

**CONSULTANT REQUEST FOR PROPOSALS**

**FOR**

**Electric Vehicle (EV) Underground Charging Infrastructure  
Preliminary Engineering and Design (PE)  
FAIN – CA-2020-207-03**

**Proposals due by Wednesday December 2, 2020  
Time: 12:00 pm**



**Butte County Association of Governments  
326 Huss Drive, Suite 150  
Chico, CA 95928**

**(530) 809-4616**

## Table of Contents

SECTION I -	Instructions to Proposers	3
SECTION II -	Proposal Content	8
SECTION III -	Scope of Services	12
SECTION IV -	Proposed Fee Schedule – Cost Proposal Package B	16
SECTION V -	Evaluation and Award	17
SECTION VI -	Proposed/Sample Agreement (Reference Information)	19

### ATTACHMENTS:

#### **Proposal Submittal Required Forms – Package A:**

##### ATTACHMENT CHECK LIST

- Exhibit A Proposed Scope of Work
- Form 1 Lobbying Certification and Disclosure of Lobbying Activities (Fill in, Sign and Date)
- Form 2 Certification Regarding Debarment, Suspension, Ineligibility and Voluntary Exclusion – Lower Tier Covered Transaction (Date, Signature Company and Title)
- Form 3 Equal Employment Opportunity Certification (Fill in and Sign at Bottom)
- Form 4 List of Proposed Subcontractors/Sub-Consultants (Fill out or DNA)
- Form 5 Public Contract Code Section 10162 Questionnaire (Yes or No)
- Form 6 BCAG – Non-Collusion Affidavit (Signature at Bottom)
- Form 7 Public Contract Code Section 10285.1 Statement (Signature at Bottom)
- Form 8 Proposer Certification Clauses and Proposal Signature Page. (Must be filled out, dated and signed)
- Form 9 Proposer/Operator/Bidder DBE – (Consultant Contracts) Information. (Must be filled out as indicated) – “DBE Information – Good Faith Efforts” Required with proposal submittal if DBE Goal not met. ***\*Note – Form 9A and 9B are supplemental information only and not required to be submitted with Form 9 in the Submittal Package A***
- Form 10 Current Client References (Must be filled out as indicated)
- Form 11 Addenda Acknowledgment (Must be filled out as indicated and include written addenda)
- Insurance Certificate
- W-9

#### **Proposal Submittal Required Forms – Package B:**

Exhibit 10-K – Consultant Annual Certification Indirect Costs and Financial Management System (Sample). **Information Required with Package - B**

#### **Reference Information: (Not required with Proposal Submittal)**

- Proposed Agreement (SAMPLE) (SECTION VI)
- Attachment I – Standard Insurance Requirements for Professional Services Contracts (SECTION VI)
- Solar Plan Set
- As Built Electrical – Butte Regional Operations Center
- Desk Audit – Loading Evaluations
- Select EV Routing Analysis
- CEQA Notice of Exemption (filed 8-28-20)
- Project Site Photos – August 2020

## **SECTION I**

### **INSTRUCTIONS TO PROPOSERS**

#### **A. Examination of Proposal Documents**

By submitting a proposal, Proposer represents that it has thoroughly examined and become familiar with the work required in this RFP and is capable of performing quality work to achieve the objectives of BCAG.

#### **B. Addenda**

Any BCAG changes to the requirements will be made by written addendum to this RFP and shall be incorporated into the terms and conditions of any resulting agreement. BCAG will not be bound to any modifications or deviations from the requirements set forth in this RFP as a result of oral instructions. Proposers shall acknowledge receipt of addenda in their proposals. Failure to acknowledge receipt of all addenda may cause a proposal to be deemed non-responsive. (Refer to Form 11 – Package A)

#### **C. BCAG Contact**

All questions and/or inquiries regarding this RFP shall be submitted in writing and directed to:

Andy Newsum, PE  
Deputy Director  
Butte County Association of Governments  
326 Huss Drive, Suite 150  
Chico, CA 95928  
Phone: (530) 809-4616  
Fax: (530) 879-2444  
E-mail: [anewsum@bcag.org](mailto:anewsum@bcag.org)

#### **D. Clarifications**

##### **1. Examination of Documents**

Should a Proposer require clarifications regarding the RFP, Proposer shall notify Andy Newsum in writing as stated above. Should it be found that the point in question is not clearly and fully set forth in the RFP, BCAG will issue a written addendum clarifying the matter(s). The written addendum will be posted on the BCAG website and must be included in the submitted proposal as stated elsewhere in this RFP.

##### **2. Submitting Requests**

- a. All questions must be submitted in writing to BCAG no later than **12:00 p.m. on Tuesday, November 10, 2020.**

- b. Requests for clarifications, questions and comments must be clearly labeled, **"Written Questions Re: Electric Vehicle (EV) Underground Charging Infrastructure Preliminary Engineering and Design (PE)"**. BCAG is not responsible for failure to respond to a request that has not been labeled as such.
- c. Any of the following methods of delivering written questions are acceptable as long as questions are received no later than the date and time specified above:
  - (1) US Mail or Personal Courier: Attention: Andy Newsum, PE, Deputy Director BCAG, 326 Huss Drive, Suite 150, Chico, CA 95928
  - (2) Facsimile: BCAG's fax number is (530) 879-2444, attention: Andy Newsum, PE
  - (3) E-mail: [anewsum@bcag.org](mailto:anewsum@bcag.org)

### **3. BCAG Responses**

Responses to all received questions will be posted on the BCAG website no later than **5:00 P.M. on Friday, November 13, 2020**

### **E. Submission of Proposals**

#### **1. Date and Time**

Proposals must be submitted on or before **Wednesday, December 2, 2020 at 12:00 PM,**

#### **2. Address**

Proposals delivered in person or by the US Postal Service shall be submitted to:

Victoria Proctor, Administrative Assistant  
Butte County Association of Governments  
326 Huss Drive, Suite 150  
Chico, CA 95928

### 3. Identification of Proposals

Proposer shall submit 2 (two) separate sealed documents:

- PACKAGE A: TECHNICAL PROPOSAL  
**1 (one) original, 3 (three) copies** of its proposal **PACKAGE A** in a sealed package and one USB, addressed as shown above, bearing the Proposer's name and address, and clearly marked as follows:

**Technical Proposal for Electric Vehicle (EV) Underground Charging  
Infrastructure Preliminary Engineering and Design (PE)**

- PACKAGE B – COST PROPOSAL:  
Refer to Section IV – Fee Schedule – Cost Proposal – Package B. **1 (one) original copy** of its cost proposal in a separate sealed package, addressed as shown above, bearing the Proposer's name and address, and clearly marked as follows:

**Cost Proposal for Electric Vehicle (EV) Underground Charging  
Infrastructure Preliminary Engineering and Design (PE)**

Exhibit 10-K – Consultant Annual Certification Indirect Costs and Financial Management System. Required with Package - B

### 4. Acceptance of Proposals

- a. BCAG reserves the right to accept or reject (see below) any or all proposals, waive any informalities or irregularities in the proposals, request additional information or revisions to the proposals, and to negotiate with any or all Proposers.
- b. BCAG reserves the right to withdraw this RFP at any time without prior notice and makes no representations that any contract will be awarded to any Proposer responding to this RFP.
- c. BCAG reserves the right to postpone the proposal opening for convenience.
- d. BCAG reserves the right to issue a new RFP for the work.
- e. Proposals received by BCAG are subject to public inspection under the California Public Records Act (Government Code Section 6250 *et seq.*), unless exempt and will be made available upon request after award.
- f. Proposals submitted are not to be copyrighted.
- g. BCAG reserves the right to require confirmation of information furnished by any Proposer and/or request any Proposer to provide additional evidence of qualifications to successfully perform the work.
- h. Any Proposal received prior to the date and time specified above for receipt or Proposals may be withdrawn or modified by written request of the Consultant. To be

considered, the modification must be received in writing, and the same number of copies as the original Proposal, prior to the date and time specified above for receipt of Proposals.

- i. No prior, current, or post award verbal conversations or agreement(s) with any officer, agent, or employee of BCAG shall affect or modify any terms or obligations of this RFP, or any contract resulting from this procurement.

## **5. Rejection of Proposals**

Failure to meet all the requirements contained in this RFP, shall be cause for rejection of the proposal. BCAG may reject any proposal if it is conditional, incomplete, contains irregularities or reflects inordinately high cost rates. Waiver of an immaterial deviation shall in no way modify the RFP documents or excuse the proposing firm/team from full compliance with the contract requirements if the proposer is awarded the contract.

Proposals not including the proper required attachments shall be deemed non-responsive. A non-responsive Proposal is one that does not meet the basic Proposal requirements. Failure to meet the submittal requirements of the Proposal shall deem it non-responsive and therefore be cause for rejection.

More than one Proposal from an individual, firm, partnership, corporation or association under the same or different names, will not be considered. Reasonable grounds for believing that any Consultant has submitted more than one proposal for the work contemplated herein will cause the rejection of all proposals submitted by that Consultant. If there is reason to believe that collusion exists among the Consultants, none of the participants in such collusion will be considered in this or future procurements.

The decision to approve and award a contract is at the discretion of the BCAG Board of Directors and resides within the authority granted to the Executive Director to accomplish the execution of any contract.

## **F. Pre-Contractual Expenses**

BCAG shall not, in any event, be liable for any pre-contractual expense incurred by Proposer in the preparation of its proposal. Pre-contractual expenses are defined as expenses incurred by Proposer in:

1. Preparing a proposal in response to this RFP
2. Submitting a proposal to BCAG
3. Negotiating with the BCAG on any matter related to its proposal
4. Any other expenses incurred by Proposer prior to date of award, should award be made to Proposer

## **G. Joint Offers**

Where two or more Proposers desire to submit a single proposal in response to this RFP, they shall do so on a prime-sub-consultant basis rather than as a joint venture. BCAG intends to contract with a single firm and not with multiple firms doing business as a joint venture.

## H. Contract Type

### Description of Design Build Process

BCAG (OWNER) desires to enter into a Design Build agreement with a single contractor or A/E consultant (CONSULTANT) for the completion of the contemplated Scope of Work for all Tasks 1-4.

Phase 1 (Tasks 1 and 2) - The first phase of the work will be for design development utilizing the information and criteria available to develop Plans, Specifications and Estimate (PS&E) to 100%. This phase of work is intended to be covered in the requested Proposal Submittal Packages A and B in detail.

Phase 2 (Tasks 3 and 4) – At completion of Task 1 and during the development of Task 2, the CONSULTANT shall develop a proposal detailing the delivery of Tasks 3 and 4 which will include a Unit Cost Construction Estimate (BID) for the delivery of construction, construction of the underground electric infrastructure and delivery of construction management related efforts. Upon approval by the OWNER of Tasks 3 and 4, the agreement will be amended to include Tasks 3 and 4.

## **SECTION II (revised)**

### **PROPOSAL CONTENT**

#### **A. Proposal Format and Content**

##### **1. Presentation**

###### **Package A:**

Proposals shall be submitted on 8 1/2" x 11" size paper, using a single method of fastening and should not include any unnecessarily elaborate promotional material. Proposers must submit one (1) sealed Proposal package marked "ORIGINAL COPY". Within that package there shall be one (1) Original Proposal and two (2) photocopies. The Original Proposal shall contain the ATTACHMENT CHECKLIST all stated required attachments. The additional two Proposal copies may contain photocopies of the original package only and must be included in the sealed package marked "ORIGINAL COPY" containing the Original Proposal. As stated above, submittals must be received by **Wednesday December 2 at 12:00 PM, 2020.** ***This is a firm deadline, and no proposals will be accepted after this time.*** All Proposals become the property of BCAG.

##### **2. Letter of Transmittal**

A Letter of Transmittal shall be addressed to Andy Newsum, PE, Deputy Director BCAG and must, at a minimum, contain the following information:

Identification of Proposer who will have contractual responsibility with BCAG. Identification shall include legal name of company, corporate address, telephone number and e-mail address of the contact person identified during the period of proposal evaluation. Provide a brief profile of the firm, including:

- Types of services offered
- The year founded
- Form of organization (corporation, partnership, or sole proprietorship);
- Number, size and location of offices
- Total number of employees

State the proposed working relationship between Proposer and sub-consultants, if applicable.

Acknowledgment of receipt of all addenda, if any.

A statement to the effect that the proposal shall remain valid for a period of not less than 90 days from the date of submittal. Signature of the official authorized to bind Proposer to the terms of the proposal. Signed statement attesting that all information submitted with the proposal is true and correct.



### 3. Technical Proposal

#### a. Qualifications, Relevant Experience and References (PS&E through Construction)

This section of the proposal shall establish the ability of the Proposer to satisfactorily perform the required work by addressing the following:

- Describe the firm's experience in performing work of a similar nature to that solicited in this RFP (Section III) and highlight participation in such work by key personnel proposed for assignment to BCAG.
- Identify key personnel proposed to perform the specified tasks and include major areas of sub - consultant work. Include a brief description or list identifying role of each project team member is proposed to fulfill on this project and their availability to work on the requested services and acknowledge that no person designated as "key" shall be removed or replaced without the prior written concurrence of the BCAG.
- Provide a minimum of three (3) references (Form 10) for completed work similar to that in scope of work contained in this RFP. Furnish contact name, title, address and telephone number of the person at each client agency who is most knowledgeable about the work performed and can attest to the competence of the services provided by the Proposer.

#### b. Subconsultants/Subcontractors

If subconsultants are to be used, identify sub-consultants (Form 4) by company name, address, contact person, telephone number and project function, if applicable. The list should include a summary of roles and responsibilities of each sub - consultant. It is expected that the discussion of subconsultants will also include experience and references to similar types of work. It is encouraged for local consulting firms to be contacted and included for portions of work that can be performed locally within Butte County. All subcontracts must be approved by BCAG, and no work shall be subcontracted without the prior written approval of BCAG.

#### c. Work Plan: The Proposer shall provide a narrative addressing the Scope of Services (Section III) and demonstrating the Proposer's understanding of the BCAG's needs and requirements. The work plan will ultimately become part of the contract and will serve as the basis for developing Exhibit A Proposed Scope of Work for the contract.

- Describe the proposed approach and work plan for completing the services specified in the Scope of Services (Section III). The Proposer shall clearly identify any additions, deletions or modifications to the Scope of Services provided and reasons or justification for doing so.

*Note: The resulting agreement is intended to be a design build agreement. The Work Plan is intended to be more specific to the development of the PS&E. Because the construction workplan will be dependent upon the ultimate design and amended to the agreement, general discussion of a construction workplan is all that is required with this proposal request.*

- d. Project Schedule: The Proposer shall provide a detailed project schedule or timeline identifying beginning and end dates for this project and all significant project tasks and milestones. The Proposer shall assume a start date of January 1, 2021.
- e. Exceptions/Deviations (PS&E Only): State any exceptions or deviations from the requirements of this RFP, segregating "technical" exceptions from "contractual" exceptions. Where the Proposer wishes to propose alternative approaches to meeting the BCAG's technical or contractual requirements, these shall be thoroughly explained.
- f. Fee Proposal (PS&E Only): **In a separate sealed envelope (Package B), provide a not-to-exceed fee proposal** to perform services described in Section III, including a **schedule of hourly rates** that will be charged to provide these services. The fee proposal shall be broken down per item/task showing total number of hours and rate extensions for all project team members involved with each item/task, sub-totals for each item/task, and a total for all proposed items/tasks, as well as for other services. Rates must be clearly identified as including fringe benefits or not. The total proposal fee stated must also include the stated profit, overhead and all extended markups for specific items. Exhibit 10-K must be submitted with Package B - Fee Proposal.
- g. Prevailing Wages (PS&E Only): Certain labor categories under this project may be subject to prevailing wages as identified in the Davis Bacon Department of Labor Federal Wage Rate Determinations **OR** State of California Labor Code commencing in Section 1770 et. seq. These labor categories when employed for any work on or in the execution of a "Public Works" project require payment of prevailing wages. In either case, the use of the higher wage will be required.
- h. W-9 Form: Submit a "W-9" form with the proposal package. See "Attachment Checklist".
- i. Conflict of Interest Disclaimer: In submitting a proposal, the proposer shall disclose any financial interest or relationship with any consulting firm or construction company that might submit a competitive RFP on the PROJECT.
- j. Acknowledgement of Insurance Requirements. The prospective consultant shall provide a summary of the firm's insurance coverage for:
- Comprehensive General Liability Insurance
  - Professional Errors and Omissions Insurance
  - Automotive Liability Insurance, and
  - Worker's Compensation Insurance

Disadvantaged Business Enterprise (DBE): It is the policy of BCAG that Disadvantaged Business Enterprises (DBEs), as defined in 49 CFR Part 26, shall have equal opportunity to participate in the performance of contracts financed in whole or in part with Federal funds under any agreement. The DBE requirements of 49 CFR Part 26 will apply to any consultant agreement. "DBE Information – Good Faith Efforts" Required with proposal submittal if DBE Goal not met. BCAG's overall goal for FFY 2020 – 2023 is 0.42%. Businesses certified with the California Department of Transportation can be identified at the following website: [http://www.dot.ca.gov/hq/bep/find\\_certified.htm](http://www.dot.ca.gov/hq/bep/find_certified.htm)

- k. Title VI Compliance: BCAG policy prohibits discrimination or preferential treatment because of race, color, religion, sex, national origin, ancestry, age (over 40), physical or

mental disability, cancer-related medical condition, a known genetic pre-disposition to a disease or disorder, veteran status, marital status, or sexual orientation.

It is the policy of BCAG to encourage and facilitate full and equitable opportunities for small local businesses to participate in its contracts for the provision of goods and services. It is further BCAG policy that no discrimination shall be permitted in small local business participation in BCAG contracts or in the subcontracting of BCAG contracts.

The successful consultant shall comply with the BCAG's non-discrimination policy. Title VI Solicitation Notice: BCAG, in accordance with the provisions of Title VI of the Civil Rights Act of 1964 (78 Stat. 252, 42 U.S.C. §§ 2000d to 2000d-4) and the Regulations, hereby notifies all bidders that it will affirmatively ensure that any contract entered into pursuant to this advertisement, disadvantaged business enterprises will be afforded full and fair opportunity to submit bids in response to this invitation and will not be discriminated against on the grounds of race, color, or national origin in consideration for an award.

BCAG reserves the right to reject any or all proposals, to waive any irregularities or informalities not affected by law, to evaluate the proposals submitted, and to award the contract according to the proposal which best serves the interests of BCAG.

Package B

Refer to Section IV – Package B – Fee Schedule Cost Proposal.

## **SECTION III**

### **SCOPE OF SERVICES**

#### **A. BACKGROUND**

The Butte County Association of Governments (BCAG) is seeking proposals from qualified professional engineering services firms (CONSULTANT) to enter into the first phase of a Design Build agreement for an underground infrastructure project to accommodate electrical vehicle charging (PROJECT) at the Butte Regional Operations and Maintenance Facility for the delivery of Butte County Public Transit also known as the B-Line.

In 2016, the Butte County Association of Governments (BCAG) completed and moved into a 5 - building campus on 10 acres comprised of approximately 50,000 square feet from which B-Line service is administrated, managed, dispatched and maintained.

In 2018, installation of a canopy mounted 450kwh solar system was completed for the purpose of providing 100% of campus electrical consumption. Over the past 2 years, the campus has been facility has been relatively balanced in electrical consumption and generation.

As a result of the State of California's administrative and policy driven direction to a phased transition of public transit to an electric vehicle delivered service, BCAG has been assessing the best way to accomplish this mandate.

In early 2019, staff was approached by PG&E to partner in developing an electric vehicle charging infrastructure and service to accommodate a multiple large vehicle charging solution on site. In coordinating with PG&E, staff learned the partnership had additional criteria, BCAG was not prepared to commit to. As such, the partnership with PG&E was not pursued pending further analysis of BCAG needs.

In communicating with other agencies both in and out of California, and in coordination with available funding sources to accomplish the transition, BCAG believes the best alternative is take a phased approach that first focuses on the design and installation of the underground structure needed to accommodate the charging of heavy electric vehicles. Concurrent with this effort is to establish a relationship with PG&E that commits to the provision of service to the property line that will accommodate the underground charging infrastructure. With these two elements of the system in place and/or well understood, competitive capital funding opportunities can be pursued for the obtainment of electric vehicles.

#### **Related PROJECT information:**

- BCAG will be administering this contract. Staff from BCAG will lead the monitoring and assess progress of the work produced by the CONSULTANT during regularly scheduled Project Development Team (PDT) meetings
- All final approvals for documents and work products generated as a result of this contract will be made by BCAG.

- “Attachments for information purposes only”. There are several attachments to the RFP with various details of what has been developed thus far for the establishment of underground charging.

## **B. SCOPE OF SERVICES (PS&E, Construction and Construction Management)**

The services consist in general, of performing all of those activities associated with developing Plans, Specification and Estimate (PS&E), including construction documents, for the installation of a 60kW or 125kW charging system at the Butte Regional Operations Center (BROC) located at 326 Huss Drive, Chico, CA 95926. Elements and tasks to be prepared or performed by the Consultant are stated as, yet not necessarily limited to the following:

### **TASK 1 – Preliminary Design Phase: Reference “Attachments for Information Purposes Only”)**

1. Attend kick-off meeting with BCAG staff.
2. Review all available documents provided by BCAG.
3. Accomplish a site assessment to determine the best alignment and location of the underground service with up to three (3) suitable locations to be identified (if necessary). The service will be constructed on site and extended to the right of way line at the back of the sidewalk of Aztec Avenue.
4. Conduct and verify there is utility service access available for contemplated upgrade at the right of way limit.
5. Conduct and verify all utility conflicts including coordination with PG&E for upgraded or new service to accommodate the underground infrastructure.
6. Lead discussion of needs with BCAG and develop a design study to assure ultimately designed and installed infrastructure will accommodate the broadest range of commercially available electric vehicle (EV) charging equipment and vehicles expected to be in service over a planning horizon.
7. Send a preliminary notice to each utility company affected by the proposed improvements. Request plans for any existing improvements, prior rights information and, if required, an estimate and schedule from each utility of any required relocation.
8. Perform a design/topographic survey under supervision of a licensed civil engineer or land surveyor. Research and record all existing improvements including, but not limited to driveways, curb, gutter, sidewalks, trees, signs, streetlights, structure, striping, power poles, vaults and other features.
9. Prepare base maps at a scale of 1" = 40' using data from items 2, 3, and 4. Plot utilities on base maps.
10. Prepare and submit preliminary construction cost estimates and 3 sets of construction plans (65% completion level). Submit draft specifications.

11. Prepare and submit preliminary construction cost estimates and 3 sets of construction plans (90% completion level) incorporating City, utility and other comments from previous submittal. Submit complete set of project specifications.
12. If applicable send final notice to each affected utility company to complete relocations prior to anticipated construction date.
13. Prepare construction plans to include minimum of the following (as applicable):
  - Title Sheet including General Notes, Utility Contract Information, NPDES General Notes, and Project Location Map.
  - Site improvement plans including Americans with Disabilities Act (ADA) compliant curb access ramps, walkways, signage, striping, etc.
  - Site electrical plans and details
  - Construction details
  - Signing and striping plan

## **BCAG Responsibilities for PS&E**

### **BCAG will:**

- Provide CEQA clearance. The project will be processed under CEQA Section Exemptions:
  - 15061(b)(3) – Activities Covered by General Rule
  - 15301 (a) – Existing Facilities
  - 15303 (d) – New Construction or Conversion of Small Structures
  - 15304 (f) – Minor Alterations to Land
- Approve the delivery of stated work products
- Participate in and coordinate the various meetings with affected agencies as needed in addition to consultant work
- Maintain a website page at [www.bcag.org](http://www.bcag.org), if required
- Pay all consultant invoices

## **TASK 2 –Final Design Phase:**

1. Prepare final construction specifications, cost estimates and plans (100% Completion level) incorporating comments from BCAG, affected agencies, and utility companies.
2. Upon BCAG approval of plans and specifications, provide final construction drawings in digital format and two (2) sets true to scale hard copies (one full size and 11 x 17), sealed and signed by a supervising California Professional Engineer. Submit project specifications in digital format.
3. Obtain all necessary permits from regulatory agencies, including, but not limited to Butte County and City of Chico, etc.

### **TASK 3 – Unit Cost Construction Estimate:**

At the completion of Tasks 1 and 2, CONSULTANT shall develop a Unit Cost Construction Estimate (BID) to complete construction of PS&E and serve as the basis for progress pay estimates.

### **TASK 4 – Construction and Management**

CONSULTANT shall be responsible to perform the Construction and Construction Manager at Risk. Construction and Management of Construction is expected to include, yet not necessarily be limited to the following:

- The provision of all labor, materials, tools and equipment to perform the construction of the final approved underground electrical infrastructure design.
- The provision of a construction management team (CMT)
- In coordination with the OWNER, obtain necessary permits, agreements and clearances for construction
- Delivery of Construction kickoff meeting with OWNER and all interested/required parties
- Management of all proposed and agreed design changes in support of Contract Change Orders (CCOs)
- Delivery of weekly construction updates
- Approval of all construction materials.
- Maintenance and management of daily work reports describing the materials, equipment, quantities and labor utilized on site
- Maintenance of certified payrolls for all labor
- Development of monthly progress pay estimates for completed work
- Complete Construction records to include all above stated items as well as Final As-Built plan set.

**SECTION IV**

**FEE SCHEDULE – COST PROPOSAL - PACKAGE B**

**Professional Engineering Services for Electric Vehicle (EV) Underground Charging Infrastructure Preliminary Engineering and Design (PE)**

The following matrix summarizes each task and its deliverables as part of this Scope of Services. The Consultant shall provide a detailed summary and Task breakdown of the staffing classifications, hourly fee, and total number of hours necessary to support each task. Each task may have more than one sub task and should be also identified within the scope of preparing the cost proposal.

<b>Item</b>	<b>Description</b>	<b>Fee</b>
Task 1	All labor, services, materials and equipment to complete Preliminary Design Services as described in Section III - Scope of Services	
Task 2	All labor, services, materials and equipment to complete Final Design Services as described in Section III - Scope of Services	
	<b>TOTAL FEE (NOT TO EXCEED)</b>	

**Note:**

Exhibit 10-K – Consultant Annual Certification Indirect Costs and Financial Management System. Required with Package - B



## SECTION V

### Evaluation and Award

#### A. Evaluation Criteria:

BCAG will review and evaluate the proposals based on the following criteria:

1. **Quality and completeness of proposal** – quality of presentation and submittal of all required items as specified in Section II, “Proposal Content.” **(10)**
2. **Qualifications of the firm** - technical experience in performing work of a similar nature; experience working with public agencies; strength and financial stability of the firm; and assessment by client references. **(20)**
3. **Proposed team and organization** - qualifications of proposed key personnel; logic of organization; and adequacy of labor commitment and resources to satisfactorily perform the requested services and meet BCAG's needs. **(25)**
4. **Detailed work plan** - thorough understanding of the BCAG's requirements and objectives; logic, clarity, specificity, creativity in approach and overall quality of work plan. **(20)**
5. **Technical knowledge and subject matter expertise** – understanding and familiarity with EV charging stations design standards and practices. **(25)**

#### B. Evaluation Procedure:

Evaluation of the Proposals will be accomplished by a selection committee composed of BCAG's Executive Director and Deputy Director/Project Manager. The selection committee will utilize the above “**Evaluation Criteria**” for submitted Proposal evaluations.

Following proposal evaluations, a “short list” of qualified consultants may be developed by the committee with up to three consultants being invited to interview with the consultant selection committee to explain their relevant experience, approach and methodology. The “short list” will be based on proposal evaluations (see above) and other actions and submissions pursuant to this RFP, information provided by former clients for whom similar work has been performed, and consideration of any exceptions taken to the proposed contract terms and conditions. Following the interview process, the consultant selection committee will rank the interviewed firms. ***The consultant selection committee may choose to forgo the interview process and begin negotiations with a top ranked consultant.*** Cost proposals will be opened for the top ranked consultant selected. In the event an agreement cannot be successfully negotiated with the top ranked consultant, the second ranked consultant will be invited to enter into negotiations. This process will be continued, if required, until a satisfactory agreement can be negotiated. Unopened cost proposals will be returned.

BCAG reserves the right to conduct interviews of a short list of firms, at its sole discretion.

**C. Contract Award:**

BCAG may negotiate contract terms with the selected Proposer prior to award and expressly reserves the right to negotiate with several Proposers simultaneously. However, since the selection and award may be made without discussion with any Proposer, the proposal submitted should contain Proposer's most favorable terms and conditions.

**Award and Protest**

- a) Notice of the proposed award shall be posted at the Butte County Association of Governments, 326 Huss Drive, Suite 150, Chico, CA 95928. (Lobby door), and on the following Internet site: [www.bcag.org](http://www.bcag.org) five (5) working days prior to awarding the Agreement.
- b) Consultants have the right to protest the award of Butte County Association of Governments Agreements subject to the following grounds, processes and procedures.
  1. If any Consultant, prior to the award of Contract, files a protest with the BCAG, it is suggested that any protests be by certified or registered mail to:

Butte County Association of Governments (BCAG)  
**Electric Vehicle (EV) Underground Charging  
Infrastructure Preliminary Engineering and Design (PE)**  
Attn: Andy Newsum  
326 Huss Drive, Suite 150  
Chico, CA 95928

2. Within five (5) days after filing the initial protest, the protesting Consultant shall file with BCAG a full and complete written statement specifying the grounds for the protest. It is suggested that complete written statements be submitted by certified or registered mail.
3. Upon award of the Contract, the Consultant must complete and submit to BCAG the Payee Data Record (STD 204), to determine if the Consultant is subject to state income tax withholding pursuant to California Revenue and Taxation Code Sections 18662. This form can be found on the Internet at [www.osp.dgs.ca.gov](http://www.osp.dgs.ca.gov) under the heading FORMS MANAGEMENT CENTER. No payment shall be made unless a completed STD 204 has been returned to the State.

**Non-Exclusivity of Contract:** It shall in no way be construed that any contract to be awarded hereby is or shall be the sole or exclusive contract for the requested service into which BCAG may enter. The Consultant has no exclusive right granted per this contract.

SECTION VI

Proposed Agreement  
**(SAMPLE)**



**BUTTE COUNTY ASSOCIATION OF GOVERNMENTS**

**CONSULTING SERVICES AGREEMENT**

Consultant

Project

**Electric Vehicle (EV) Underground Charging Infrastructure Preliminary Engineering and Design (PE)**

THIS AGREEMENT made and entered into this XX day of Month 2020, by and between Butte County Association of Governments, hereinafter referred to as "BCAG", and CONSULTANT hereinafter referred to as "CONSULTANT".

**WITNESSETH:**

**SECTION 1 - ORGANIZATION AND CONTENTS**

<b>SECTION 1</b>	<b>ORGANIZATION AND CONTENTS</b>
<b>SECTION 2</b>	<b>SCOPE OF CONSULTING SERVICES - BASIC</b>
<b>SECTION 3</b>	<b>SCOPE OF CONSULTING SERVICES - ADDITIONAL</b>
<b>SECTION 4</b>	<b>NOTICE TO PROCEED; PROGRESS; COMPLETION</b>
<b>SECTION 5</b>	<b>TIME OF PERFORMANCE</b>
<b>SECTION 6</b>	<b>COMPENSATION</b>
<b>SECTION 7</b>	<b>CHANGES TO SCOPE - BASIC</b>
<b>SECTION 8</b>	<b>COMPLIANCE WITH LAWS, RULES, REGULATIONS</b>
<b>SECTION 9</b>	<b>ENERGY CONSERVATION</b>
<b>SECTION 10</b>	<b>CLEAN WATER</b>
<b>SECTION 11</b>	<b>CLEAN AIR</b>
<b>SECTION 12</b>	<b>RECYCLED PRODUCTS</b>
<b>SECTION 13</b>	<b>EXHIBITS INCORPORATED</b>
<b>SECTION 14</b>	<b>RESPONSIBILITY OF CONSULTANT</b>
<b>SECTION 15</b>	<b>RESPONSIBILITY OF BCAG</b>
<b>SECTION 16</b>	<b>NO OBLIGATION BY THE FEDERAL GOVERNMENT</b>
<b>SECTION 17</b>	<b>TERM</b>
<b>SECTION 18</b>	<b>TERMINATION FOR CONVENIENCE OF BCAG</b>
<b>SECTION 19</b>	<b>TERMINATION OF AGREEMENT FOR CAUSE</b>

<b>SECTION 20</b>	<b>GOVERNMENT-WIDE DEBARMENT AND SUSPENSION</b>
<b>SECTION 21</b>	<b>PRIVACY ACT</b>
<b>SECTION 22</b>	<b>INTEREST OF OFFICIALS AND CONSULTANT</b>
<b>SECTION 23</b>	<b>SUBCONTRACTING</b>
<b>SECTION 24</b>	<b>SUCCESSORS AND ASSIGNS</b>
<b>SECTION 25</b>	<b>INDEPENDENT CONSULTANT</b>
<b>SECTION 26</b>	<b>BREACHES AND DISPUTES</b>
<b>SECTION 27</b>	<b>EQUAL EMPLOYMENT OPPORTUNITY</b>
<b>SECTION 28</b>	<b>DISADVANTAGED BUSINESS ENTERPRISE <i>(Federal Funding)</i></b>
<b>SECTION 29</b>	<b>CIVIL RIGHTS-TITLE VI COMPLIANCE</b>
<b>SECTION 30</b>	<b>PUBLICATIONS</b>
<b>SECTION 31</b>	<b>COPYRIGHTS</b>
<b>SECTION 32</b>	<b>INDEMNIFICATION</b>
<b>SECTION 33</b>	<b>INSURANCE REQUIREMENTS</b>
<b>SECTION 34</b>	<b>OWNERSHIP OF DOCUMENTS</b>
<b>SECTION 35</b>	<b>ACCESS TO RECORDS</b>
<b>SECTION 36</b>	<b>NOTICES</b>
<b>SECTION 37</b>	<b>JURISDICTION</b>
<b>SECTION 38</b>	<b>INTEGRATION</b>

**EXHIBITS**

<b>EXHIBIT A</b>	<b>SCOPE OF WORK</b>
<b>EXHIBIT B</b>	<b>COMPENSATION</b>
<b>EXHIBIT C</b>	<b>CERTIFICATION OF OWNER <i>(Federal Funding)</i></b>
<b>EXHIBIT D</b>	<b>CERTIFICATION OF CONSULTANT <i>(Federal Funding)</i></b>
<b>EXHIBIT E</b>	<b>SCOPE OF CONSULTING SERVICES – ADDITIONAL</b>
<b>ATTACHMENT I</b>	<b>STANDARD INSURANCE REQUIREMENTS</b>
<b>Exhibit 10-O2</b>	<b>DBE UTILIZATION <i>(Federal Funding)</i></b>

Form 1	Lobbying Certification and Disclosure of Lobbying Activities
Form 2	Certification Regarding Debarment, Suspension, Ineligibility and Voluntary Exclusion – Lower Tier Covered Transaction
Form 3	Equal Employment Opportunity Certification
Form 4	List of Proposed Subcontractors/Sub-Consultants
Form 5	Public Contract Code Section 10162 Questionnaire
Form 6	BCAG – Non-Collusion Affidavit
Form 7	Public Contract Code Section 10285.1 Statement
Form 8	Proposer Certification Clauses and Proposal Signature Page.
Form 9	Local Agency Proposer/Operator/Bidder DBE – (Consultant Contracts) Information.

Insurance Certificate  
W-9 Form

## **SECTION 2 - SCOPE OF CONSULTING SERVICES - BASIC**

CONSULTANT agrees to perform all work necessary to complete in a manner satisfactory to BCAG, those items described in "***Exhibit A, Scope of Work***", attached hereto and incorporated herein by this reference as if set forth in full.

For the purposes of a general description, the work to accomplish under this AGREEMENT is generally referred to as the preparation of the Post Camp Fire Regional Population & Transportation Study (PROJECT).

CONSULTANT shall submit a detailed progress report to BCAG with each billing invoice describing the progress of the work completed during the billing period by task.

**Note:** Sections of the agreement marked (***Federal Funding***) will apply for federal funding only. Inclusion of federal funding will require an amendment approved in writing by both parties per Sections 3 and 7 of the agreement. Because BCAG is a federally designated entity, some applicable clauses and requirements must remain.

## **SECTION 3 - SCOPE OF CONSULTING SERVICES - ADDITIONAL**

It is understood by BCAG and CONSULTANT that it may be necessary, in connection with this project, for CONSULTANT to perform or secure the performance of related services other than those set forth in "***Exhibit A - Scope of Work***". In each such instance, CONSULTANT shall advise BCAG, in advance and in writing, of the need for such additional services, their cost and the estimated time required to perform them (if appropriate). CONSULTANT shall not proceed to perform any such additional service until BCAG has determined that such service is beyond the scope of the basic services to be provided by CONSULTANT, is required, and has given its written authorization to perform or obtain it. Each additional service so authorized shall constitute an amendment to this AGREEMENT, shall be identified and sequentially numbered as "Additional Consulting Service No. 1" and so forth, shall be subject to all of the provisions of this AGREEMENT, and shall be attached as ***Exhibit "E"*** entitled "***SCOPE OF CONSULTING SERVICES - ADDITIONAL***".

## **SECTION 4 - NOTICE TO PROCEED; PROGRESS; COMPLETION**

Upon execution of this AGREEMENT by the parties, BCAG shall give CONSULTANT notice to proceed with the work by issuance of signed letter or equivalent. Such notice may authorize CONSULTANT to render all of the services contemplated herein, or such portions or phases as may be mutually agreed upon. In the latter event, BCAG shall, in its sole discretion, issue subsequent notices from time to time regarding further portions or phases of the work. Upon receipt of such notices, CONSULTANT shall diligently proceed with the work authorized and complete it within the agreed time period.

## **SECTION 5 - TIME OF PERFORMANCE**

CONSULTANT shall commence work upon receipt of Notice to Proceed. The various items involved in the Project shall be completed as indicated in "***Exhibit A- Scope of Work***". CONSULTANT shall complete the performance of its obligations under this AGREEMENT within the specified time period, unless an extension of time is granted in

writing by BCAG, which said extension, if any, shall be granted only for good cause as determined at the sole discretion of BCAG.

## **SECTION 6 - COMPENSATION**

For services performed pursuant to this AGREEMENT, BCAG agrees to pay CONSULTANT in accordance with the work scope shown in "**Exhibit A - Scope of Work**". All payment will be on the basis of the Estimated Budget as shown in "**Exhibit B - Compensation**" for the completion of this project. Total payments shall not exceed **\$XX** as shown in the estimated budget in "**Exhibit B – Compensation**", without prior notice by the CONSULTANT and approval in writing by BCAG. Upon clarification of scope, compensation may be adjusted as approved in writing by BCAG.

### **A. Other Direct Costs**

The CONSULTANT agrees that the Contract Cost Principles and Procedures, CFR 48, Federal Acquisition Regulations System, Chapter 1, Part 31, shall be used to determine the allowability of individual items of cost. The CONSULTANT also agrees to comply with **CFR 49, part 18, Uniform Administrative Requirements for Grants and Cooperative Agreements to State and Local Governments**. Any costs for which payment has been made to CONSULTANT that are determined by subsequent audit to be unallowable under CFR 48, Federal Acquisition Regulations System, Chapter 1, Part 31, are subject to repayment by CONSULTANT to BCAG.

Other direct costs which may be allowed for compensation are included in "**Exhibit B – Compensation**"

### **B. Monthly Compensation**

CONSULTANT shall be reimbursed monthly no later than thirty (30) days following submission of a written, acceptable billing to BCAG. Said billing shall indicate the number of hours worked by each category of CONSULTANT'S personnel, and the other direct and indirect costs incurred to the date of such billing, if any, and the fixed fee determined proportionately based on the percentage of work completed. BCAG will pay, to CONSULTANT, 100% of submitted monthly invoices for work completed under "**Exhibit A - Scope of Work**" until 90% of "**Exhibit B - Compensation**", including any compensation for all agreed upon amendments, has been reached. At this time, the remaining 10% of "**Exhibits B – Compensation**", including compensation for all agreed upon amendments, will be retained until the completion of all work as defined in "**Exhibit A - Scope of Work**".

### **C. Final Payment**

CONSULTANT shall, after the completion of all work under the AGREEMENT, submit a final billing for work done thereunder, and BCAG shall pay the entire sum up to the Cost Ceiling stated in "**Exhibit B – Compensation**", as found due after deducting therefrom all previous payments. All prior payments shall be subject to correction in the final payment. The final payment shall not be due and payable until the expiration of thirty (30) days following submission, by CONSULTANT, of a

written acceptable final billing to BCAG or as otherwise determined by BCAG. It is mutually agreed between the parties to this AGREEMENT that no payments made under the AGREEMENT, except the final payment, shall be conclusive evidence of the performance of the AGREEMENT, either wholly or in part, against any claim of the CONSULTANT, and no payment shall be construed to be in acceptance of any defective work or improper materials.

#### **SECTION 7 - CHANGES TO SCOPE - BASIC**

BCAG may at any time, and upon a minimum of ten (10) days' written notice, modify the scope of basic services to be provided under this AGREEMENT. CONSULTANT shall, upon receipt of said notice, determine the impact on both time and compensation of such change in scope and notify BCAG in writing. Upon AGREEMENT between BCAG and CONSULTANT as to the extent of said impacts on time and compensation, an amendment to this AGREEMENT shall be prepared describing such changes. Execution of the amendment by BCAG and CONSULTANT shall constitute the CONSULTANT's notice to proceed with the changed scope, including all adjustments in compensation.

#### **SECTION 8 - COMPLIANCE WITH LAWS, RULES, REGULATIONS-FEDERAL CHANGES**

All services performed by CONSULTANT pursuant to this AGREEMENT shall be performed in accordance and full compliance with all applicable Federal, State or City statutes, and any rules or regulations promulgated thereunder.

CONSULTANT shall at all times comply with all applicable regulations, policies, procedures and directives, including without limitation those listed directly or by reference, as they may be amended or promulgated from time to time during the term of this contract. CONSULTANT's failure to so comply shall constitute a material breach of this contract.

#### **SECTION 9 – ENERGY CONSERVATION**

CONSULTANT agrees to comply with mandatory standards and policies relating to energy efficiency which are contained in the state energy conservation plan issued in compliance with the Energy Policy and Conservation Act.

#### **SECTION 10 – CLEAN WATER**

- A. CONSULTANT agrees to comply with all applicable standards, orders or regulations issued pursuant to the Federal Water Pollution Control Act, as amended, 33 U.S.C. 1251 et seq. CONSULTANT agrees to report each violation to BCAG and understands and agrees that BCAG will, in turn, report each violation as required to assure notification to the appropriate EPA Regional Office.
  
- B. CONSULTANT also agrees to include these requirements in each subcontract exceeding \$100,000 financed in whole or in part with Federal assistance.

#### **SECTION 11 – CLEAN AIR**

CONSULTANT agrees to comply with all applicable standards, orders or regulations

issued pursuant to the Clean Air Act, as amended, 42 U.S.C. §§ 7401 et seq. CONSULTANT agrees to report each violation to the Purchaser and understands and agrees that the BCAG will, in turn, report each violation as required to assure notification to the appropriate EPA Regional Office. CONSULTANT also agrees to include these requirements in each subcontract exceeding \$100,000 financed in whole or in part with Federal assistance.

### **SECTION 12 – RECYCLED PRODUCTS**

**Recovered Materials** - The CONSULTANT agrees to comply with all the requirements of Section 6002 of the Resource Conservation and Recovery Act (RCRA), as amended (42 U.S.C. 6962), including but not limited to the regulatory provisions of 40 CFR Part 247, and Executive Order 12873, as they apply to the procurement of the items designated in Subpart B of 40 CFR Part 247 as can be accommodated by the agreed upon in ***“Exhibit A - Scope of Work”***.

### **SECTION 13 - EXHIBITS INCORPORATED**

All Exhibits referred to in this AGREEMENT and attached to it are hereby incorporated in it by this reference.

### **SECTION 14 - RESPONSIBILITY OF CONSULTANT**

By executing this AGREEMENT, CONSULTANT warrants to BCAG that he/she possesses, or will arrange to secure from others, all of the necessary professional consulting capabilities, experience, resources and facilities to provide to BCAG the services contemplated under this AGREEMENT. CONSULTANT further warrants that he/she will follow the current, generally accepted practice of the consulting profession to make findings, render opinions, prepare factual presentations, and provide professional advice and recommendations regarding the project for which services are rendered under this AGREEMENT.

### **Program Fraud and False or Fraudulent Statements or Related Acts (*Federal Funding*)**

- A. CONSULTANT acknowledges that the provisions of the Program Fraud Civil Remedies Act of 1986, as amended, 31 U.S.C. § 3801 et seq. and U.S. DOT regulations, "Program Fraud Civil Remedies," 49 C.F.R. Part 31, apply to its actions pertaining to this Project. Upon execution of the underlying contract, CONSULTANT certifies or affirms the truthfulness and accuracy of any statement it has made, it makes, it may make, or causes to be made, pertaining to the underlying contract for which this contract work is being performed. In addition to other penalties that may be applicable, CONSULTANT further acknowledges that if it makes, or causes to be made, a false, fictitious, or fraudulent claim, statement, submission, or certification, the Federal Government reserves the right to impose the penalties of the Program Fraud Civil Remedies Act of 1986 on CONSULTANT to the extent the Federal Government deems appropriate.
- B. CONSULTANT also acknowledges that if it makes, or causes to be made, a false, fictitious, or fraudulent claim, statement, submission, or certification to the Federal



Government under a contract connected with a project that is financed in whole or in part with Federal assistance originally awarded by FTA under the authority of 49 U.S.C. § 5307, the Government reserves the right to impose the penalties of 18 U.S.C. § 1001 and 49 U.S.C. § 5307(n)(1) on CONSULTANT, to the extent the Federal Government deems appropriate. **(Federal Funding)**

- C. CONSULTANT agrees to include the above two clauses in each subcontract financed in whole or in part with Federal assistance provided by FTA if applicable. It is further agreed that the clauses shall not be modified, except to identify the sub-CONSULTANT who will be subject to the provisions. **(Federal Funding)**

### **SECTION 15 - RESPONSIBILITY OF BCAG**

To the extent appropriate to the project contemplated by this AGREEMENT, BCAG shall:

- A. Assist CONSULTANT by placing at his/her disposal all available information pertinent to the project, including previous reports and any other relevant data.
- B. Guarantee access to and make all provisions for CONSULTANT to enter upon public and private property as required for CONSULTANT to perform his/her services.
- C. Examine all studies, reports, proposals and other documents presented by CONSULTANT, and render verbally or in writing as may be appropriate, decisions pertaining thereto within a reasonable time so as not to delay the services of CONSULTANT.
- D. Designate in writing a person to act as BCAG's representative with respect to all work to be performed under this AGREEMENT. Such person shall have complete authority to transmit instructions, receive information, interpret and define BCAG's policies and decisions with respect to materials, equipment, elements and systems pertinent to CONSULTANT's services.
- E. Furnish approvals and permits from all governmental authorities having jurisdiction over the PROJECT and such approvals and consents from others as may be necessary for completion of the PROJECT.

### **SECTION 16 – NO OBLIGATION BY THE FEDERAL GOVERNMENT (Federal Funding)**

- A. BCAG and CONSULTANT acknowledge and agree that, notwithstanding any concurrence by the Federal Government in or approval of the solicitation or award of the underlying contract, absent the express written consent by the Federal Government, the Federal Government is not a party to this contract and shall not be subject to any obligations or liabilities to BCAG, CONSULTANT, or any other party (whether or not a party to that contract) pertaining to any matter resulting from the underlying contract.

- B. CONSULTANT agrees to include the above clause in each subcontract financed in whole or in part with Federal assistance provided by FTA as applicable. It is further agreed that the clause shall not be modified, except to identify the sub-CONSULTANT who will be subject to its provisions.

#### **SECTION 17 - TERM**

The term of this AGREEMENT shall commence upon BCAG's issuance to CONSULTANT of a Notice to Proceed for all or a portion of the work as hereinabove provided, and shall end upon BCAG's acceptance and payment for such portion of the work as was authorized by such notice. ***The term of the contract shall be in effect from the date of contract execution through XX,XX***

#### **SECTION 18 - TERMINATION FOR CONVENIENCE OF BCAG**

BCAG may terminate this AGREEMENT, in whole or in part, at any time by written notice to the CONSULTANT when it is in BCAG's best interest. The CONSULTANT shall be paid its costs, including contract close-out costs, and profit on work performed up to the time of termination. The CONSULTANT shall promptly submit its termination claim to BCAG to be paid the CONSULTANT. If the CONSULTANT has any property in its possession belonging to BCAG, the CONSULTANT will account for the same, and dispose of it in the manner BCAG directs. If this contract is terminated, BCAG shall be liable only for payment under the payment provisions of this contract for services rendered before the effective date of termination.

#### **SECTION 19 - TERMINATION OF AGREEMENT FOR CAUSE**

If CONSULTANT fails to perform in the manner called for in the contract, or if the CONSULTANT fails to comply with any other provisions of the contract, BCAG may terminate this contract for default. Termination shall be effected by serving a notice of termination on the contractor setting forth the manner in which CONSULTANT is in default. CONSULTANT will only be paid the contract price for services performed in accordance with the manner of performance set forth in the contract.

If it is later determined by BCAG that CONSULTANT had an excusable reason for not performing, such as a strike, fire, or flood, events which are not the fault of or are beyond the control of CONSULTANT, BCAG, after setting up a new delivery of performance schedule, may allow CONSULTANT to continue work, or treat the termination as a termination for convenience.

- A. BCAG may, by written notice to CONSULTANT, terminate the whole or any part of this AGREEMENT in any one of the following circumstances:
1. If CONSULTANT fails to perform the services called for by this AGREEMENT within the time(s) specified herein, or any extension thereof; or
  2. If CONSULTANT fails to perform the services called for by this AGREEMENT or so fails to make progress as to endanger performance of this AGREEMENT in accordance with its terms, and in either of these two circumstances does not correct such failure within a period of ten (10) days (or such longer period as

BCAG may authorize in writing) after receipt of notice from BCAG specifying such failure.

- B. In the event BCAG terminates this AGREEMENT in whole or in part as provided in Paragraph "A" above, BCAG may procure, upon such terms and in such manner as it may determine appropriate, services similar to those terminated.
- C. Except with respect to defaults of sub-contractors/sub-CONSULTANTS, CONSULTANT shall not be liable for any excess costs if the failure to perform arises out of causes beyond the control and without the fault or negligence of CONSULTANT. Such causes include, but are not limited to, acts of God or of the public enemy, acts of government, in either its sovereign or contractual capacity, fires, floods, epidemics, quarantine restrictions, strikes, and unusually severe weather. In the event the failure to perform is caused by the default of a sub-contractor/sub-CONSULTANT, CONSULTANT shall not be liable for failure to perform, unless the services to be furnished by the sub-contractor were obtainable from other sources in sufficient time and within budgeted resources to permit CONSULTANT to meet the required delivery schedule or other performance requirements.
- D. Should the AGREEMENT be terminated as provided in Paragraph "A" above, CONSULTANT shall provide BCAG with all finished and unfinished documents, data, studies, services, drawings, maps, models, photographs, reports, compact disks (CDs), etc., prepared by CONSULTANT pursuant to this AGREEMENT. Upon termination as provided in Paragraph "A" above, CONSULTANT shall be paid the value of the work performed, as determined by BCAG, less payments of compensation previously made. Payments previously made by BCAG to CONSULTANT shall be credited to the amount payable to CONSULTANT for allowable costs as provided herein, except, however, CONSULTANT shall be entitled to a proportionate fixed fee, if any, which in the opinion of BCAG, it has legitimately earned and was not related to the cause for which this AGREEMENT was terminated.
- E. If after notice of termination of this AGREEMENT, as provided for in this Section, it is determined for any reason that CONSULTANT was not in default under the provisions of this Section or that the default was excusable under the provisions of this Section, then the rights and obligations of the parties shall be the same as if the AGREEMENT had been terminated for the convenience of BCAG.
- F. **Opportunity to Cure:** BCAG in its sole discretion may, in the case of a termination for breach or default, allow CONSULTANT ten (10) days in which to cure the defect. In such case, the notice of termination will state the time period in which cure is permitted and other appropriate conditions

If CONSULTANT fails to remedy to BCAG satisfaction the breach or default of any of the terms, covenants, or conditions of this AGREEMENT within ten (10) days after receipt by CONSULTANT of written notice from BCAG setting forth the nature

of said breach or default, BCAG shall have the right to terminate the AGREEMENT without any further obligation to CONSULTANT. Any such termination for default shall not in any way operate to preclude BCAG from also pursuing all available remedies against CONSULTANT and its sureties for said breach or default.

- G. **Waiver of Remedies for any Breach:** In the event that BCAG elects to waive its remedies for any breach by CONSULTANT of any covenant, term or condition of this AGREEMENT, such waiver by BCAG shall not limit BCAG's remedies for any succeeding breach of that or of any other term, covenant, or condition of this AGREEMENT.

**SECTION 20 – GOVERNMENT-WIDE DEBARMENT AND SUSPENSION (Federal Funding)** This AGREEMENT is a covered transaction for purposes of 49 CFR Part 29. As such, the CONSULTANT is required to verify that neither the CONSULTANT, or its principals, as defined at 49 CFR 29.995, or affiliates, as defined at 49 CFR 29.905, are excluded or disqualified as defined at 49 CFR 29.940 and 29.945.

CONSULTANT is required to comply with 49 CFR 29, Subpart C and must include the requirement to comply with 49 CFR 29, Subpart C in any lower tier covered transaction it enters into.

By signing this agreement and/or submitting a bid, Request for Proposals (RFP) or Request for Qualifications (RFQ), the submission will satisfy the following:

*The certification in this clause is a material representation of fact relied upon by BCAG. If it is later determined that the bidder/proposer/submitting body knowingly rendered an erroneous certification, in addition to remedies available to BCAG, the Federal Government may pursue available remedies, including but not limited to suspension and/or debarment. The bidder or proposer agrees to comply with the requirements of 49 CFR 29, Subpart C while this offer is valid and throughout the period of any AGREEMENT that may arise from this offer. The bidder/proposer/submitting body further agrees to include a provision requiring such compliance in its lower tier covered transactions.*

**SECTION 21 – PRIVACY ACT (Federal Funding)**

**Contracts Involving Federal Privacy Act Requirements (if applicable)** - The following requirements apply to CONSULTANT and its employees that administer any system of records on behalf of the Federal Government under any AGREEMENT:

- A. CONSULTANT agrees to comply with, and assures the compliance of its employees with, the information restrictions and other applicable requirements of the Privacy Act of 1974, 5 U.S.C. § 552a. Among other things, CONSULTANT agrees to obtain the express consent of the Federal Government before CONSULTANT or its employees operate a system of records on behalf of the Federal Government. CONSULTANT understands that the requirements of the Privacy Act, including the civil and criminal penalties for violation of that Act, apply

to those individuals involved, and that failure to comply with the terms of the Privacy Act may result in termination of the underlying AGREEMENT.

- B. CONSULTANT also agrees to include these requirements in each subcontract to administer any system of records on behalf of the Federal Government financed in whole or in part with Federal assistance provided by FTA.

#### **SECTION 22 - INTEREST OF OFFICIALS AND CONSULTANT (Federal Funding)**

- A. No member of or delegate to the Congress of the United States of America or any Resident Commissioner shall be admitted to any share or part hereof or to any benefits to arise here from.
- B. CONSULTANT hereby covenants that he or she has, at the time of the execution of this AGREEMENT, no interest, and that he or she shall not acquire any interest in the future, direct or indirect, which would conflict in any manner or degree with the performance of services required to be performed pursuant to this AGREEMENT. CONSULTANT further covenants that in the performance of this work, no person having any such interest shall be employed.

#### **SECTION 23 - SUBCONTRACTING**

- A. CONSULTANT shall not sub-contract or otherwise assign any portion of the work to be performed under this AGREEMENT without the prior written approval of BCAG.
- B. Nothing contained in this AGREEMENT or otherwise, shall create any contractual relation between BCAG and any sub-CONSULTANTS, and no sub-contract shall relieve the CONSULTANT of his/her responsibilities and obligations hereunder. The CONSULTANT agrees to be fully responsible to BCAG for the acts and omissions of its sub-CONSULTANTS and of the persons either directly or indirectly employed by any of them as it is for the acts and omissions of persons directly employed by the CONSULTANT. The CONSULTANT'S obligation to pay its sub-CONSULTANTS is an independent obligation for BCAG's obligation to make payments to the CONSULTANT.
- C. CONSULTANT shall pay its sub-CONSULTANTS within thirty (30) calendar days from receipt of each payment made to the CONSULTANT by BCAG.
- D. Any substitution of sub-CONSULTANTS must be approved in writing by BCAG's Contract Manager in advance of assigning work to a substitute sub-CONSULTANT.

#### **SECTION 24 - SUCCESSORS AND ASSIGNS**

This AGREEMENT shall be binding upon and shall insure to the benefit of any successors to or assigns of the parties. CONSULTANT shall not assign, delegate or transfer the rights and duties under this AGREEMENT or any part thereof without the prior written consent of BCAG.

## **SECTION 25 - INDEPENDENT CONSULTANT**

BCAG and CONSULTANT agree that CONSULTANT is an independent Consultant. CONSULTANT shall be solely responsible for the conduct and control of the work performed under this AGREEMENT. CONSULTANT shall be free to render consulting services to others during the term of this AGREEMENT, so long as such activities do not interfere with or diminish CONSULTANT's ability to fulfill the obligations established herein to BCAG.

## **SECTION 26 – BREACHES AND DISPUTES**

**Disputes** - Disputes arising in the performance of this AGREEMENT which are not resolved by agreement of the parties shall be decided in writing by the authorized representative of BCAG's Executive Director. This decision shall be final and conclusive unless within ten (10) days from the date of receipt of its copy, CONSULTANT mails or otherwise furnishes a written appeal to the Executive Director. In connection with any such appeal, CONSULTANT shall be afforded an opportunity to be heard and to offer evidence in support of its position. The decision of the Executive Director shall be final, subject to appeal by arbitration if the parties mutually agree or otherwise to a court of competent jurisdiction with the State in which BCAG is located.

**Performance During Dispute** - Unless otherwise directed by BCAG, CONSULTANT shall continue performance under this AGREEMENT while matters in dispute are being resolved.

**Claims for Damages** - Should either party to the AGREEMENT suffer injury or damage to person or property because of any act or omission of the party or of any of his employees, agents or others for whose acts he is legally liable, a claim for damages therefore shall be made in writing to such other party within a reasonable time after the first observance of such injury of damage.

**Remedies** - Unless this AGREEMENT provides otherwise, all claims, counterclaims, disputes and other matters in question between the BCAG and CONSULTANT arising out of or relating to this agreement or its breach will be decided by arbitration if the parties mutually agree, or in a court of competent jurisdiction within the State in which BCAG is located.

**Rights and Remedies** - The duties and obligations imposed by the AGREEMENT Documents and the rights and remedies available thereunder shall be in addition to and not a limitation of any duties, obligations, rights and remedies otherwise imposed or available by law. No action or failure to act by BCAG or CONSULTANT shall constitute a waiver of any right or duty afforded any of them under the AGREEMENT, nor shall any such action or failure to act constitute an approval of or acquiescence in any breach thereunder, except as may be specifically agreed in writing.

## **SECTION 27 - EQUAL EMPLOYMENT OPPORTUNITY**

In connection with the execution of this AGREEMENT, CONSULTANT shall not discriminate against any employee or applicant for employment because of race, religion, color, sex or national origin. CONSULTANT shall take affirmative action to

ensure that applicants are employed, and the employees are treated during their employment, without regard to their race, religion, color, sex or national origin. Such actions shall include, but not be limited to, the following: employment, upgrading, demotion or transfer; recruitment or recruitment advertising; layoff or termination; rates of pay or other forms of compensation; and selection for training, including apprenticeship. CONSULTANT shall comply with Executive Order 11246, entitled "Equal Employment Opportunity" as amended by Executive Order 11375, and as supplemented in Department of Labor Regulations (41 CFR Part 60), the California Fair Employment and Housing Act, and any other applicable Federal and State laws and regulations relating to equal employment opportunity.

**SECTION 28 - DISADVANTAGED BUSINESS ENTERPRISE (Federal Funding)**

CONSULTANT may, at its discretion, take the following measures to facilitate participation by disadvantaged business enterprises (DBE) in the Project:

- A. This AGREEMENT is subject to the requirements of Title 49, Part 26 of the Code of Federal Regulations entitled, "Participation by Disadvantaged Business Enterprises in the Department of Transportations Financial Assistance Programs". The national goal for participation of DBE is 10%. DBE participation on this AGREEMENT will assist STATE in meeting its federally mandated statewide overall DBE goal. BCAG has not established a DBE Availability Advisory Percentage for this AGREEMENT.
- B. DBE and other small businesses (SB), as defined in Title 49 CFR, Part 26 are encouraged to participate in the performance of agreements financed in whole or in part with federal funds. The CONSULTANT, sub-recipient or sub-CONSULTANT shall not discriminate on the basis of race, color, national origin, or sex in the performance of this AGREEMENT. The CONSULTANT shall carry out applicable requirements of 49 CFR, Part 26 in the award and administration of US DOT-assisted agreements. Failure by the CONSULTANT to carry out these requirements is a material breach of this AGREEMENT, which may result in the termination of this AGREEMENT or such other remedy as the recipient deems appropriate.
- C. Any subcontract entered into as a result of this AGREEMENT shall contain all of the provisions of this section.
- D. A DBE performs a commercially useful function when it is responsible for execution of the work of the AGREEMENT and is carrying out its responsibilities by actually performing, managing and supervising the work involved. To perform a commercially useful function, the DBE must also be responsible with respect to materials and supplies used on the AGREEMENT, for negotiating price, determining quality and quantity, ordering the material, and installing (where applicable) and paying for the material itself. To determine whether the DBE is performing a commercially useful function, evaluate the amount of work subcontracted, industry practices; whether the amount the firm is paid under the

AGREEMENT is commensurate with the work it is actually performing, and other relevant factors.

- E. A DBE does not perform a commercially useful function if its role is limited to that of an extra participant in a transaction, AGREEMENT, or project through which funds are passed in order to obtain the appearance of DBE participation. In determining whether a DBE is such an extra participant, examine similar transactions, particularly those in which DBEs do not participate.
- F. If a DBE does not perform or exercise responsibility for at least thirty percent (30%) of the total cost of its AGREEMENT with its own work force, or the DBE subcontracts a greater portion of the work of the AGREEMENT than would be expected on the basis of normal industry practice for the type of work involved, it will be presumed that it is not performing a commercially useful function.
- G. The successful bidder/offeror will be required to report its DBE participation obtained through race-neutral means throughout the period of performance.
- H. CONSULTANT must promptly notify BCAG, whenever a DBE subcontractor performing work related to this AGREEMENT is terminated or fails to complete its work, and must make good faith efforts to engage another DBE subcontractor to perform at least the same amount of work. CONSULTANT may not terminate any DBE subcontractor and perform that work through its own forces or those of an affiliate without prior written consent of BCAG.

Exhibit 10-02 shows a commitment of 15% in SUBCONSULTANT work to be counted as DBE utilization. Modification to actual utilization will be as approved in writing by BCAG.

#### **SECTION 29 - TITLE VI COMPLIANCE (Federal Funding)**

The following requirements apply to the underlying AGREEMENT:

- A. Nondiscrimination - In accordance with Title VI of the Civil Rights Act, as amended, 42 U.S.C. § 2000d, section 303 of the Age Discrimination Act of 1975, as amended, 42 U.S.C. § 6102, section 202 of the Americans with Disabilities Act of 1990, 42 U.S.C. § 12132, and Federal transit law at 49 U.S.C. § 5332, CONSULTANT agrees that it will not discriminate against any employee or applicant for employment because of race, color, creed, national origin, sex, age, or disability. In addition, CONSULTANT agrees to comply with applicable Federal implementing regulations and other implementing requirements FTA may issue.
- B. Equal Employment Opportunity - The following equal employment opportunity requirements apply to the underlying AGREEMENT:
  - 1. Race, Color, Creed, National Origin, Sex - In accordance with Title VII of the Civil Rights Act, as amended, 42 U.S.C. § 2000e, and Federal transit laws at 49 U.S.C. § 5332, CONSULTANT agrees to comply with all applicable equal



employment opportunity requirements of U.S. Department of Labor (U.S. DOL) regulations, "Office of Federal Contract Compliance Programs, Equal Employment Opportunity, Department of Labor," 41 C.F.R. Parts 60 et seq., (which implement Executive Order No. 11246, "Equal Employment Opportunity," as amended by Executive Order No. 11375, "Amending Executive Order 11246 Relating to Equal Employment Opportunity," 42 U.S.C. § 2000e note), and with any applicable Federal statutes, executive orders, regulations, and Federal policies that may in the future affect construction activities undertaken in the course of the Project. CONSULTANT agrees to take affirmative action to ensure that applicants are employed, and that employees are treated during employment, without regard to their race, color, creed, national origin, sex, or age. Such action shall include, but not be limited to, the following: employment, upgrading, demotion or transfer, recruitment or recruitment advertising, layoff or termination; rates of pay or other forms of compensation; and selection for training, including apprenticeship. In addition, CONSULTANT agrees to comply with any implementing requirements FTA may issue.

2. Age - In accordance with section 4 of the Age Discrimination in Employment Act of 1967, as amended, 29 U.S.C. § § 623 and Federal transit law at 49 U.S.C. § 5332, CONSULTANT agrees to refrain from discrimination against present and prospective employees for reason of age. In addition, CONSULTANT agrees to comply with any implementing requirements FTA may issue.

3. Disabilities - In accordance with section 102 of the Americans with Disabilities Act, as amended, 42 U.S.C. § 12112, CONSULTANT agrees that it will comply with the requirements of U.S. Equal Employment Opportunity Commission, "Regulations to Implement the Equal Employment Provisions of the Americans with Disabilities Act," 29 C.F.R. Part 1630, pertaining to employment of persons with disabilities. In addition, CONSULTANT to comply with any implementing requirements FTA may issue.

C. CONSULTANT also agrees to include these requirements in each subcontract financed in whole or in part with Federal assistance provided by FTA, modified only if necessary to identify the affected parties.

### **SECTION 30 - PUBLICATION**

A. Any and all reports published by CONSULTANT shall acknowledge that it was prepared in cooperation with BCAG.

B. Articles, reports, or works reporting on the work provided for herein or on portions thereof which are published by CONSULTANT shall contain in the foreword, preface, or footnote the following statement:

"The contents of this report reflect the view of the author who is responsible for the facts and accuracy of the data presented herein. The contents do not necessarily reflect the official views of BCAG. This report does not constitute a standard, specification, or regulation."

### **SECTION 31 - COPYRIGHTS**

CONSULTANT shall be free to copyright material developed under this AGREEMENT with the provision that BCAG reserve a royalty-free, nonexclusive, and irrevocable license to reproduce, publish or otherwise use, and to authorize others to use the material for government or public purposes.

### **SECTION 32 - INDEMNIFICATION**

CONSULTANT agrees to indemnify and hold BCAG, its officers, boards and commissions, and members thereof, its employees and agents harmless of and free from any and all liabilities, including all claims, losses, expenses, fees including attorney fees, costs, and judgments that may be asserted against BCAG to the extent caused by the negligent acts, errors or omissions of CONSULTANT, CONSULTANT's employees, and CONSULTANT's agents. BCAG agrees, to the fullest extent permitted by law, to indemnify and hold the CONSULTANT harmless from any damage, liability or cost (including reasonable attorneys' fees and costs of defense) to the extent caused by BCAG's negligent acts, errors or omissions and those of BCAG's CONSULTANTS, sub-CONSULTANTS or anyone for whom BCAG is legally liable, and arising from the project that is the subject of this AGREEMENT.

### **SECTION 33 - INSURANCE REQUIREMENTS**

CONSULTANT shall procure and maintain for the duration of the AGREEMENT insurance against claims for injuries to persons or damages to property which may arise from or in connection with the performance of work hereunder by the CONSULTANT, his/her agents, representatives, or employees. At the very least, CONSULTANT shall maintain the insurance coverage, limits of coverage and other requirements as described in ***Attachment I (Professional Services)*** attached to and made a part of this AGREEMENT.

### **SECTION 34 - OWNERSHIP OF DOCUMENTS**

Original documents, methodological explanations, CD-ROMs, computer programs, drawings, designs and reports generated by this AGREEMENT ("Work Product") shall belong to and become the property of BCAG in accordance with accepted standards relating to public work contracts. Any additional copies, not otherwise provided for herein, shall be the responsibility of BCAG. BCAG shall indemnify and hold harmless CONSULTANT for any use or reuse of said Work Product except of the original intent related to the PROJECT covered by this AGREEMENT. Notwithstanding any provision to the contrary in any provision, no rights, titles, and interests, including but not limited to all ownership and intellectual property rights, in any inventions, improvements, discoveries, methodologies, models, formats, software, algorithms, processes, procedures, designs, specifications, findings, other intellectual properties developed, gathered, compiled or produced by CONSULTANT or any third-party prior to or independently of any of its services under this Agreement ("Background IP"), including such Background IP that CONSULTANT may employ in the performance of this AGREEMENT, or may incorporate into any part of the Work Products shall be transferred or assigned to BCAG. CONSULTANT shall grant and shall secure for BCAG an irrevocable, non-exclusive, transferable, royalty-free, license in perpetuity to use,

disclose, derive from such Background IP, but only as an inseparable part of the Work Products.

### **SECTION 35 - ACCESS TO RECORDS**

CONSULTANT shall document the results of the work to the satisfaction of BCAG. Such documentation may include preparation of progress and final reports, plans, specifications and estimates, or similar evidence of attainment of AGREEMENT objectives.

CONSULTANT and its sub-CONSULTANTS shall maintain all books, documents, papers, accounting records, and other evidence pertaining to costs incurred, and make such materials available at their respective offices at all reasonable times during the AGREEMENT period and for three years from the date of final payment to CONSULTANT. Such materials shall be available for inspection by authorized representatives of BCAG, or the copies thereof shall be furnished if requested.

CONSULTANT agrees to provide the BCAG, or any of their authorized representatives access to any books, documents, papers and records of the CONSULTANT which are directly pertinent to this AGREEMENT for the purposes of making audits, examinations, excerpts and transcriptions.

CONSULTANT agrees to permit any of the foregoing parties to reproduce by any means whatsoever or to copy excerpts and transcriptions as reasonably needed.

CONSULTANT agrees to maintain all books, records, accounts and reports required under this AGREEMENT for a period of not less than three years after the date of termination or expiration of this AGREEMENT, except in the event of litigation or settlement of claims arising from the performance of this AGREEMENT, in which case CONSULTANT agrees to maintain same until BCAG or any of their duly authorized representatives, have disposed of all such litigation, appeals, claims or exceptions related thereto. Reference 49 CFR 18.39(i)(11).FTA does not require the inclusion of these requirements in subcontracts.

### **SECTION 36 - NOTICES**

Any notices required to be given pursuant to this AGREEMENT shall be deemed to have been given by their deposit, postage prepaid, in the United States Postal Service, addressed to the parties as follows:

- A. To BCAG:                    Andy Newsum, Deputy Director  
                                      Butte County Association of Governments  
                                      326 Huss Drive, Suite 150  
                                      Chico, CA 95928
  
- B. To CONSULTANT: Name, Title  
                                      Address  
                                      City, State, Zip

Nothing hereinabove shall prevent either BCAG or CONSULTANT from personally delivering any such notices to the other.

**SECTION 37 – JURISDICTION**

Except as otherwise specifically provided, this AGREEMENT shall be administered and interpreted under the laws of the State of California. Jurisdiction of litigation arising from this AGREEMENT shall be in that State. If any part of this AGREEMENT is found to be in conflict with applicable laws, such part shall be inoperative, null and void insofar as it is in conflict with said laws, but the remainder of the AGREEMENT shall be in full force and effect.

**SECTION 38 – INTEGRATION**

This AGREEMENT represents the entire understanding of BCAG and CONSULTANT as to those matters contained herein. No prior oral or written understanding shall be of any force or effect with respect to those matters covered hereunder. This AGREEMENT may not be modified or altered except in writing signed by BCAG and CONSULTANT. The preceding provisions include, in part, certain Standard Terms and Conditions required by DOT, whether or not expressly set forth in the preceding AGREEMENT provisions. All contractual provisions required by DOT are hereby incorporated by reference. Anything to the contrary herein notwithstanding DOT mandated terms shall be deemed to control in the event of a conflict with other provisions contained in this Agreement. CONSULTANT shall not perform any act, fail to perform any act, or refuse to comply with any BCAG requests causing BCAG to be in violation of DOT terms and conditions **(Federal Funding)**.

**IN WITNESS WHEREOF**, the parties hereto have made and executed this AGREEMENT the day and year first above written.

**BCAG:**

**CONSULTANT:**

By \_\_\_\_\_  
**Andy Newsum, Deputy Director**

By \_\_\_\_\_  
**Name, Title**

Date: \_\_\_\_\_

Date: \_\_\_\_\_

## **Exhibit “A” – Scope of Work**

## Exhibit "B" – COMPENSATION

**Exhibit "C"**  
**CERTIFICATION OF OWNER** *(Federal Funding)*

I HEREBY CERTIFY that I am the **Deputy Director of the Butte County Association of Governments** and that the consulting firm of \_\_\_\_\_ or its representatives have not been required, directly or indirectly, as an express or implied condition in connection with obtaining or carrying out the AGREEMENT to:

- a. Employ, retain, agree to employ or retain, any firm or person; or
- b. Pay or agree to pay, to any firm, person or organization, any fee, contribution, donation, or consideration of any kind.

I acknowledge that this Certificate is to be made available to the California Department of Transportation (Caltrans) and the Federal Highway Administration in connection with this AGREEMENT involving participation of Federal Highway Administration funds, and is subject to applicable State and Federal laws, both criminal and civil.

\_\_\_\_\_  
Andy Newsum, Deputy Director

\_\_\_\_\_  
Date

**Exhibit "D"**  
**CERTIFICATION OF CONSULTANT** *(Federal Funding)*

I HEREBY CERTIFY that I am \_\_\_\_\_, and the duly authorized representative of \_\_\_\_\_, whose address is \_\_\_\_\_ and that, except as hereby expressly stated, neither I nor the above firm that I represent have:

- employed or retained for a commissions, percentage, brokerage, contingent fee, or other consideration, any firm or person, (other than a bona fide employee working solely for me or the above consultant) to solicit or secure this AGREEMENT;
- nor agreed, as an express or implied condition, for obtaining this AGREEMENT, to employ or retain the services of any firm or person in connection with carrying out the AGREEMENT;
- nor paid, or agreed to pay, to any firm, organization or person (other than a bona fide employees working solely for me or the above consultant) any fee, contribution, donation, or consideration of any kind for, or in connection with, procuring or carrying out this AGREEMENT.

I acknowledge that this Certificate is to be made available to the California Department of Transportation (Caltrans) and the Federal Highway Administration in connection with this AGREEMENT involving participation of Federal Highway Administration funds, and is subject to applicable State and Federal laws, both criminal and civil.

\_\_\_\_\_  
Signature:

\_\_\_\_\_  
Date



Attachment I – Standard Insurance Requirements (Professional Services)  
(rev.11-16)

**Before the commencement of work, Consultant shall submit Certificates of Insurance and Endorsements evidencing that Consultant has obtained the following forms of coverage and minimal amounts specified:**

**A. MINIMUM SCOPE OF INSURANCE**

- 1.) Commercial General Liability coverage (Insurance Services Office (ISO) “occurrence” form CG 0001 04 13).
- 2.) Automobile Liability Insurance – standard coverage offered by insurance carriers licensed to sell auto liability insurance in California. Construction contracts only - Insurance Services Office’s Business Auto Coverage form number CA 0001 03 10 covering “any auto”.
- 3.) Workers’ Compensation Insurance as required by the Labor Code and Employers Liability Insurance.
- 4.) Professional Liability Insurance - when the contract involves professional services such as engineering architectural, legal, accounting, instructing, and consulting, professional liability insurance is required. **(If not contracting for professional services, delete this paragraph.)**

**B. MINIMUM LIMITS OF INSURANCE**

- 1.) **General Liability:** At least \$1,000,000 combined single limit **per occurrence** coverage for bodily injury, personal injury and property damage, plus an annual aggregate of at least \$2,000,000. If a general aggregate limit is used, then either the general aggregate limit shall apply separately to this project/location, or the general aggregate limit shall be **twice** the required per occurrence limit. The Consultant or consultant’s insurance carrier shall notify BCAG if incurred losses covered by the policy exceed 50% of the annual aggregate limit.
- 2.) **Automobile Liability:** Policy limits for work in connection with construction projects shall be at least \$1,000,000 combined single limit per accident for bodily injury and property damage for autos used by the Consultant to fulfill the requirements of this contract, and coverage shall be provided for “Any Auto”, Code 1 as listed on the Acord form Certificate of Insurance.
- 3.) **Workers’ Compensation and Employers Liability:** Workers’ Compensation insurance up to policy limits and Employers Liability insurance each with policy limits of at least \$1,000,000 for bodily injury or disease.
- 4.) **Professional Liability Insurance (If not contracting for professional services, delete this paragraph)** Professional liability insurance covering professional services shall be provided in an amount of at least \$1,000,000 per occurrence or \$1,000,000 or on a claims made basis. However, if coverage is written on a claims made basis, the policy shall be endorsed to provide at least a two-year extended reporting provision.

**C. DEDUCTIBLES**

Any deductibles must be declared on certificates of insurance and approved by BCAG.

**D. OTHER INSURANCE PROVISIONS**

**1. General liability insurance policies shall be endorsed to state:**

- a.) BCAG, its officers, officials, employees and volunteers are to be covered as insured as respects liability arising out of activities performed by or at the direction of the Consultant, including products and completed operations of the Consultant, premises owned, occupied or used by the Consultant. The coverage shall contain no special limitations on the scope of protection afforded to BCAG, its officers, officials, employees or volunteers. Auto coverage as provided by unendorsed CA 0001 03 10.
- b.) Consultant's insurance coverage shall be primary insurance, except for auto, as respects BCAG, its officers, officials, employees, and volunteers. Any insurance or self-insurance maintained by BCAG, its officers, officials, employees or volunteers shall be in excess of the Consultant's insurance and shall not contribute with it.
- c.) Consultant's insurance shall apply separately to each insured against whom claim is made or suit is brought, except with respect to the limits of the insurer's liability.

**E. ACCEPTABILITY OF INSURANCE CARRIERS.**

Insurance is to be placed with insurers who are licensed to sell insurance in the State of California and who possess a Best's rating of no less than A-: VII. If the consultant's insurance carrier is not licensed to sell insurance in the State of California, then the carrier must possess a Best rating of at least A: VIII. (For Best ratings go to <http://www.ambest.com/>)

**F. VERIFICATION OF COVERAGE.**

Consultant shall furnish BCAG **certificates of insurance** and original **endorsements** affecting coverage required by this clause. All certificates of insurance and endorsements are to be received and approved by BCAG before work under the contract has begun. BCAG reserves the right to require complete, certified copies of all insurance policies required by this contract.

**G. SUBCONTRACTORS.**

Consultant shall include all subcontractors as insured under its policies or require all subcontractors to be insured under their own policies. If subcontractors are insured under their own policies, they shall be subject to all the requirements stated herein, including providing BCAG certificates of insurance and endorsements before beginning work under this contract.

## Exhibit 10-O2 Local Agency Consultant DBE Utilization

1. Local Agency: \_\_\_\_\_ 2. Contract DBE Goal: \_\_\_\_\_  
 3. Project Description: \_\_\_\_\_  
 4. Project Location: \_\_\_\_\_  
 5. Consultant's Name: \_\_\_\_\_ 6. Prime Certified DBE:  7. Total Contract Award Amount: \_\_\_\_\_  
 8. Total Dollar Amount for **ALL** Subconsultants: \_\_\_\_\_ 9. Total Number of **ALL** Subconsultants: \_\_\_\_\_

10. Description of Work, Service, or Materials Supplied	11. DBE Certification Number	12. DBE Contact Information	13. DBE Dollar Amount
<b>Local Agency to Complete this Section</b>			
20. Local Agency Contract Number: _____ 21. Federal-Aid Project Number: _____ 22. Contract Execution Date: _____  Local Agency certifies that all DBE certifications are valid and information on this form is complete and accurate.			<b>14. TOTAL CLAIMED DBE PARTICIPATION</b>
			\$
			%
23. Local Agency Representative's _____ 24. Date _____ 25. Local Agency Representative's _____ 26. Phone _____ 27. Local Agency Representative's _____ Title _____			IMPORTANT: Identify all DBE firms being claimed for credit, regardless of tier. Written confirmation of each listed DBE is required.  15. Preparer's Signature _____ 16. Date _____ 17. Preparer's _____ 18. Phone _____ 19. Preparer's _____ Title _____

**DISTRIBUTION:** 1. Original – Local Agency  
 2. Copy – Caltrans District Local Assistance Engineer (DLAE). Failure to submit to DLAE within 30 days of contract execution may result in de-obligation of federal funds on contract.

**ADA Notice:** For individuals with sensory disabilities, this document is available in alternate formats. For information call (916) 654-6410 or TDD (916) 654-3880 or write Records and Forms Management, 1120 N Street, MS-89, Sacramento, CA 95814.

## INSTRUCTIONS – CONSULTANT CONTRACT DBE COMMITMENT

### CONSULTANT SECTION

- 1. Local Agency** - Enter the name of the local or regional agency that is funding the contract.
- 2. Contract DBE Goal** - Enter the contract DBE goal percentage as it appears on the project advertisement.
- 3. Project Description** - Enter the project description as it appears on the project advertisement (Bridge Rehab, Seismic Rehab, Overlay, Widening, etc).
- 4. Project Location** - Enter the project location as it appears on the project advertisement.
- 5. Consultant's Name** - Enter the consultant's firm name.
- 6. Prime Certified DBE** - Check box if prime contractor is a certified DBE.
- 7. Total Contract Award Amount** - Enter the total contract award dollar amount for the prime consultant.
- 8. Total Dollar Amount for ALL Subconsultants** – Enter the total dollar amount for all subcontracted consultants. SUM = (DBEs + all Non-DBEs). Do not include the prime consultant information in this count.
- 9. Total number of ALL subconsultants** – Enter the total number of all subcontracted consultants. SUM = (DBEs + all Non-DBEs). Do not include the prime consultant information in this count.
- 10. Description of Work, Services, or Materials Supplied** - Enter description of work, services, or materials to be provided. Indicate all work to be performed by DBEs including work performed by the prime consultant's own forces, if the prime is a DBE. If 100% of the item is not to be performed or furnished by the DBE, describe the exact portion to be performed or furnished by the DBE. See LAPM Chapter 9 to determine how to count the participation of DBE firms.
- 11. DBE Certification Number** - Enter the DBE's Certification Identification Number. All DBEs must be certified on the date bids are opened.
- 12. DBE Contact Information** - Enter the name, address, and phone number of all DBE subcontracted consultants. Also, enter the prime consultant's name and phone number, if the prime is a DBE.
- 13. DBE Dollar Amount** - Enter the subcontracted dollar amount of the work to be performed or service to be provided. Include the prime consultant if the prime is a DBE. See LAPM Chapter 9 for how to count full/partial participation.
- 14. Total Claimed DBE Participation** - \$: Enter the total dollar amounts entered in the "DBE Dollar Amount" column. %: Enter the total DBE participation claimed ("Total Participation Dollars Claimed" divided by item "Total Contract Award Amount"). If the total % claimed is less than item "Contract DBE Goal," an adequately documented Good Faith Effort (GFE) is required (see Exhibit 15-H DBE Information - Good Faith Efforts of the LAPM).
- 15. Preparer's Signature** - The person completing the DBE commitment form on behalf of the consultant's firm must sign their name.
- 16. Date** - Enter the date the DBE commitment form is signed by the consultant's preparer.
- 17. Preparer's Name** - Enter the name of the person preparing and signing the consultant's DBE commitment form.
- 18. Phone** - Enter the area code and phone number of the person signing the consultant's DBE commitment form.
- 19. Preparer's Title** - Enter the position/title of the person signing the consultant's DBE commitment form.

### LOCAL AGENCY SECTION

- 20. Local Agency Contract Number** - Enter the Local Agency contract number or identifier.
- 21. Federal-Aid Project Number** - Enter the Federal-Aid Project Number.
- 22. Contract Execution Date** - Enter the date the contract was executed.

**23. Local Agency Representative's Signature** - The person completing this section of the form for the Local Agency must sign their name to certify that the information in this and the Consultant Section of this form is complete and accurate.

**24. Date** - Enter the date the DBE commitment form is signed by the Local Agency Representative.

**25. Local Agency Representative's Name** - Enter the name of the Local Agency Representative certifying the consultant's DBE commitment form.

**26. Phone** - Enter the area code and phone number of the person signing the consultant's DBE commitment form.

**27. Local Agency Representative Title** - Enter the position/title of the Local Agency Representative certifying the consultant's DBE commitment form.

## **ATTACHMENTS**

## PROPOSAL SUBMITTAL REQUIRED FORMS – PACKAGE A

### ATTACHMENT CHECKLIST

Package A must include the items identified below. Complete this checklist to confirm the items in your Proposal. Place a check mark or “X” next to each item that you are submitting to BCAG. All Forms identified below are applicable to this Request for Proposal (RFP) and must be returned, as instructed, for your Proposal to be responsive **Return this checklist with your Proposal Package A.**

**\*\*\*\*\* Note: Proposer shall be synonymous with any form of the words Consultant \*\*\*\*\***

#### Proposal and Forms

**NOTE:** Together with Exhibit “A” – Proposed Scope of Work, this Checklist must be submitted as a cover with the following exhibits in Proposal Package A and the Exhibit A:

- Form 1 - Lobbying Certification and Disclosure of Lobbying Activities (Fill in, Sign and Date)
- Form 2 - Certification Regarding Debarment, Suspension, Ineligibility and Voluntary Exclusion – Lower Tier Covered Transaction (Date, Signature Company and Title)
- Form 3 - Equal Employment Opportunity Certification (Fill in and Sign at Bottom)
- Form 4 - List of Proposed Subcontractors/Subconsultants (Fill out or DNA)
- Form 5 – Public Contract Code Section 10162 Questionnaire (Yes or No)
- Form 6 - BCAG – Non-Collusion Affidavit (Signature at Bottom)
- Form 7 - Public Contract Code Section 10285.1 Statement (Signature at Bottom)
- Form 8 - Proposer/Operator Certification Clauses and Proposal Signature Page. (Must be filled out, dated and signed)
- Form 9 –Proposer/Operator/Bidder DBE – (Consultant Contracts) Information. (Must be filled out as indicated) “DBE Information – Good Faith Efforts” (GFE) required with proposal submittal if DBE Goal not met. If goal is met, GFE form not required with Package A submittal *\*Note – Form 9A and 9B are supplemental information only and not required to be submitted with Form 9 in the Submittal Package A*
- Form 10 – Current Client References (Must be filled out as indicated)
- Form 11 –Addenda Acknowledgment (Must be filled out as indicated and include the written addendums)
- Insurance Certificate
- W-9

**Form 1**

**LOBBYING CERTIFICATION**

The undersigned \_\_\_\_\_ certifies, to the best of his or her knowledge and belief, that:

(1) No Federal appropriated funds have been paid or will be paid, by or on behalf of the undersigned, to any person for influencing or attempting to influence an officer or employee of an agency, a Member of Congress, an officer or employee of Congress, or an employee of a Member of Congress in connection with the awarding of any Federal contract, the making of any Federal grant, the making of any Federal loan, the entering into of any cooperative agreement, and the extension, continuation, renewal, amendment, or modification of any Federal contract, grant, loan, or cooperative agreement.

(2) If any funds other than Federal appropriated funds have been paid or will be paid to any person for making lobbying contacts to an officer or employee of any agency, a Member of Congress, an officer or employee of Congress, or an employee of a Member of Congress in connection with this Federal contract, grant, loan, or cooperative agreement, the undersigned shall complete and submit Standard Form--LLL, "Disclosure Form to Report Lobbying," in accordance with its instructions [as amended by "Government wide Guidance for New Restrictions on Lobbying," 61 Fed. Reg. 1413 (1/19/96). Note: Language in paragraph (2) herein has been modified in accordance with Section 10 of the Lobbying Disclosure Act of 1995 (P.L. 104-65, to be codified at 2 U.S.C. 1601, *et seq.*)]

(3) The undersigned shall require that the language of this certification be included in the award documents for all subawards at all tiers (including subcontracts, subgrants, and contracts under grants, loans, and cooperative agreements) and that all SUBCONSULTANTS shall certify and disclose accordingly.

This certification is a material representation of fact upon which reliance was placed when this transaction was made or entered into. Submission of this certification is a prerequisite for making or entering into this transaction imposed by 31, U.S.C. § 1352 (as amended by the Lobbying Disclosure Act of 1995). Any person who fails to file the required certification shall be subject to a civil penalty of not less than \$10,000 and not more than \$100,000 for each such failure.

[Note: Pursuant to 31 U.S.C. § 1352(c)(1)-(2)(A), any person who makes a prohibited expenditure or fails to file or amend a required certification or disclosure form shall be subject to a civil penalty of not less than \$10,000 and not more than \$100,000 for each such expenditure or failure.]

The CONSULTANT, \_\_\_\_\_, certifies or affirms the truthfulness and accuracy of each statement of its certification and disclosure, if any. In addition, the CONSULTANT understands and agrees that the provisions of 31 U.S.C. A 3801, *et seq.*, apply to this certification and disclosure, if any.

\_\_\_\_\_  
Signature of CONSULTANT'S Authorized Official

\_\_\_\_\_  
Name and Title of CONSULTANT'S Authorized Official

Date \_\_\_\_\_



**Form 1 (cont'd)**

**DISCLOSURE OF LOBBYING ACTIVITIES**

COMPLETE THIS FORM TO DISCLOSE LOBBYING ACTIVITIES PURSUANT TO 31 U.S.C. 1352

**No Lobbying Activities Performed by Proposer** (check if true and skip to signature box beside box 16)

- 1. Type of Federal Action:**
  - a. contract
  - b. grant
  - c. cooperative agreement
  - d. loan
  - e. loan guarantee
  - f. loan insurance
- 2. Status of Federal Action:**
  - a. bid/offer/application
  - b. initial award
  - c. post-award
- 3. Report Type:**
  - a. initial
  - b. material change

**For Material Change Only:**  
year \_\_\_\_\_ quarter \_\_\_\_\_  
date of last report \_\_\_\_\_

- 4. Name and Address of Reporting Entity**
  - Prime \_\_\_\_\_
  - Subawardee \_\_\_\_\_
  - Tier \_\_\_\_\_, if known
- 5. If Reporting Entity in No. 4 is Subawardee, Enter Name and Address of Prime:**

**Congressional District, if known** \_\_\_\_\_

- 6. Federal Department/Agency:** \_\_\_\_\_
- 7. Federal Program Name/Description:** \_\_\_\_\_
- CFDA Number, if applicable** \_\_\_\_\_

- 8. Federal Action Number, if known:** \_\_\_\_\_
- 9. Award Amount, if known:** \_\_\_\_\_

- 10. a. Name and Address of Lobby Entity**  
(If individual, last name, first name, MI) \_\_\_\_\_
- b. Individuals Performing Services** (including address if different from No. 10a)  
(last name, first name, MI) \_\_\_\_\_

(attach Continuation Sheet(s) if necessary)

- 11. Amount of Payment (check all that apply)**  
\$ \_\_\_\_\_  
Actual \_\_\_\_\_ planned \_\_\_\_\_
- 12. Form of Payment (check all that apply):**
  - a. cash
  - b. in-kind; specify: nature \_\_\_\_\_ value \_\_\_\_\_
- 13. Type of Payment (check all that apply)**
  - a. retainer
  - b. one-time fee
  - c. commission
  - d. contingent fee
  - e. deferred
  - f. other, specify \_\_\_\_\_

**14. Brief Description of Services Performed or to be performed and Date(s) of Service, including officer(s), employee(s), or member(s) contacted, for Payment Indicated in Item 11:**

- 15. Continuation Sheet(s) attached:** Yes \_\_\_\_\_ No \_\_\_\_\_

**16.** Information requested through this form is authorized by Title 31 U.S.C. Section 1352. This disclosure of lobbying reliance was placed by the tier above when his transaction was made or entered into. This disclosure is required pursuant to 31 U.S.C. 1352. This information will be reported to Congress semiannually and will be available for public inspection. Any person who fails to file the required disclosure shall be subject to a civil penalty of not less than \$10,000 and not more than \$100,000 for each such failure.

Signature: \_\_\_\_\_  
Print Name: \_\_\_\_\_  
Title: \_\_\_\_\_  
Telephone No.: \_\_\_\_\_ Date: \_\_\_\_\_

## Form 1 (continued)

Standard Form LLL Rev. 09-12-97

### INSTRUCTIONS FOR COMPLETION OF SF-LLL, DISCLOSURE OF LOBBYING ACTIVITIES

This disclosure form shall be completed by the reporting entity, whether sub-awardee or prime Federal recipient, at the initiation or receipt of covered Federal action or a material change to previous filing pursuant to title 31 U.S.C. section 1352. The filing of a form is required for such payment or agreement to make payment to lobbying entity for influencing or attempting to influence an officer or employee of any agency, a Member of Congress an officer or employee of Congress or an employee of a Member of Congress in connection with a covered Federal action. Attach a continuation sheet for additional information if the space on the form is inadequate. Complete all items that apply for both the initial filing and material change report. Refer to the implementing guidance published by the Office of Management and Budget for additional information.

1. Identify the type of covered Federal action for which lobbying activity is and/or has been secured to influence, the outcome of a covered Federal action.
2. Identify the status of the covered Federal action.
3. Identify the appropriate classification of this report. If this is a follow-up report caused by a material change to the information previously reported, enter the year and quarter in which the change occurred. Enter the date of the last, previously submitted report by this reporting entity for this covered Federal action.
4. Enter the full name, address, city, state and zip code of the reporting entity. Include Congressional District if known. Check the appropriate classification of the reporting entity that designates if it is or expects to be a prime or sub award recipient. Identify the tier of the sub awardee, e.g., the first sub awardee of the prime is the first tier. Sub awards include but are not limited to subcontracts, sub grants and contract awards under grants.
5. If the organization filing the report in Item 4 checks "Sub awardee" then enter the full name, address, city, state and zip code of the prime Federal recipient. Include Congressional District, if known.
6. Enter the name of the Federal agency making the award or loan commitment. Include at least one organization level below agency name, if known. For example, Department of Transportation, United States Coast Guard.
7. Enter the Federal program name or description for the covered Federal action (item 1). If known, enter the full Catalog of Federal Domestic Assistance (CFDA) number for grants, cooperative agreements, loans and loan commitments.
8. Enter the most appropriate Federal identifying number available for the Federal action identification in item 1 (e.g., Request for Proposal (RFP) number, Invitation for Bid (IFB) number, grant announcement number, the contract grant. or loan award number, the application/proposal control number assigned by the Federal agency). Include prefixes, e.g., "RFP-DE-90-001."
9. For a covered Federal action where there has been an award or loan commitment by the Federal agency, enter the Federal amount of the award/loan commitments for the prime entity identified in item 4 or 5.
10. (a) Enter the full name, address, city, state and zip code of the lobbying entity engaged by the reporting entity identified in item 4 to influenced the covered Federal action.  
(b) Enter the full names of the individual(s) performing services and include full address if different from 10 (a). Enter Last Name, First Name and Middle Initial (MI).
11. Enter the amount of compensation paid or reasonably expected to be paid by the reporting entity (item 4) to the lobbying entity (item 10). Indicate whether the payment has been made (actual) or will be made (planned). Check all boxes that apply. If this is a material change report, enter the cumulative amount of payment made or planned to be made.
12. Check the appropriate box(es). Check all boxes that apply. If payment is made through an in-kind contribution, specify the nature and value of the in-kind payment.
13. Check the appropriate box(es). Check all boxes that apply. If other, specify nature.
14. Provide a specific and detailed description of the services that the lobbyist has performed or will be expected to perform and the date(s) of any services rendered. Include all preparatory and related activity not just time spent in actual contact with Federal officials. Identify the Federal officer(s) or employee(s) contacted or the officer(s) employee(s) or Member(s) of Congress that were contacted.
15. Check whether or not a continuation sheet(s) is attached.
16. The certifying official shall sign and date the form, print his/her name title and telephone number.

Public reporting burden for this collection of information is estimated to average 30 minutes per response, including time for reviewing instruction, searching existing data sources, gathering and maintaining the data needed, and completing and reviewing the collection of information. Send comments regarding the burden estimate or any other aspect of this collection of information, including suggestions for reducing this burden, to the Office of Management and Budget, Paperwork Reduction Project (0348-0046), Washington, D.C. 20503.

## Form 2

# CERTIFICATION REGARDING DEBARMENT, SUSPENSION INELIGIBILITY AND VOLUNTARY EXCLUSION LOWER TIER COVERED TRANSACTION

### Instructions for Certification

1. By signing and submitting this bid or proposal, the prospective lower tier participant is providing the signed certification set out below.
2. The certification in this clause is a material representation of fact upon which reliance was placed when this transaction was entered into. If it is later determined that the prospective lower tier participant knowingly rendered an erroneous certification, in addition to other remedies available to the Federal Government, BCAG may pursue available remedies, including suspension and/or debarment.
3. The prospective lower tier participant shall provide immediate written notice to BCAG if at any time the prospective lower tier participant learns that its certification was erroneous when submitted or has become erroneous by reason of changed circumstances.
4. The terms "covered transaction," "debarred," "suspended," "ineligible," "lower tier covered transaction," "participant," "persons," "lower tier covered transaction," "principal," "proposal," and "voluntarily excluded," as used in this clause, have the meanings set out in the Definitions and Coverage sections of rules implementing Executive Order 12549 [49 CFR Part 29]. You may contact BCAG for assistance in obtaining a copy of those regulations.
5. The prospective lower tier participant agrees by submitting this proposal that, should the proposed covered transaction be entered into, it shall not knowingly enter into any lower tier covered transaction with a person who is debarred, suspended, declared ineligible, or voluntarily excluded from participation in this covered transaction, unless authorized in writing by BCAG.
6. The prospective lower tier participant further agrees by submitting this proposal that it will include the clause titled "Certification Regarding Debarment, Suspension, Ineligibility and Voluntary Exclusion - Lower Tier Covered Transaction", without modification, in all lower tier covered transactions and in all solicitations for lower tier covered transactions.
7. A participant in a covered transaction may rely upon a certification of a prospective participant in a lower tier covered transaction that it is not debarred, suspended, ineligible, or voluntarily excluded from the covered transaction, unless it knows that the certification is erroneous. A participant may decide the method and frequency by which it determines the eligibility of its principals. Each participant may, but is not required to, check the Nonprocurement List issued by U.S. General Service Administration.
8. Nothing contained in the foregoing shall be construed to require establishment of system of records in order to render in good faith the certification required by this clause. The knowledge and information of a participant is not required to exceed that which is normally possessed by a prudent person in the ordinary course of business dealings.
9. Except for transactions authorized under Paragraph 5 of these instructions, if a participant in a covered transaction knowingly enters into a lower tier covered transaction with a person who is suspended, debarred, ineligible, or voluntarily excluded from participation in this transaction, in addition to all remedies available to the Federal Government, BCAG may pursue available remedies including suspension and/or debarment.

**Form 2 (continued)**

10. The prospective lower tier participant certifies, by submission of this bid or proposal, that neither it nor its "principals" [as defined at 49 C.F.R. § 29.105(p)] is presently debarred, suspended, proposed for debarment, declared ineligible, or voluntarily excluded from participation in this transaction by any Federal department or agency.

11. When the prospective lower tier participant is unable to certify to the statements in this certification, such prospective participant shall attach an explanation to this proposal.

Date \_\_\_\_\_

Signature \_\_\_\_\_

Company Name \_\_\_\_\_

Title \_\_\_\_\_

**Form 3**

**EQUAL EMPLOYMENT OPPORTUNITY CERTIFICATION**

The Proposer/Operator \_\_\_\_\_,  
proposed sub-consultant \_\_\_\_\_, hereby certifies  
that he has \_\_\_\_\_, has not \_\_\_\_\_ participated in a previous contract or subcontract subject to the equal  
opportunity clause, as required by Executive Orders 10925, 11114, or 11246, and that, he has filed with the  
Joint Reporting committee, the Director of the Office of Federal Contract Compliance, a Federal Government  
contracting or administering agency, or the former President's Committee on Equal Employment Opportunity,  
all reports due under the applicable filing requirements and has an Affirmative Action Program/Plan in place  
that will be utilized for this agreement.

Note: The above certification is required by the Equal Employment Opportunity Regulations of the Secretary  
of Labor (41 CFR 60-1.7(b)(1) and must be submitted by Proposer and proposed sub-consultants only in  
connection with contracts and subcontracts which are subject to the equal opportunity clause.

Contracts and subcontracts which are exempt from the equal opportunity clause are set forth in 41 CFR  
60-1.5 (Generally, only contracts or subcontracts of \$10,000 or under are exempt.)

Currently, Standard form 100 (EEO-1) is the only report required by the Executive Orders or their  
implementing regulations.

Proposer and proposed sub-consultants who have participated in a previous contract or subcontract  
subject to the Executive Orders and have not filed the required reports should note that 41 CFR 60-  
1.07(b)(1) prevents the award of contracts and subcontracts unless such contractor submits a report  
covering the delinquent period or such other period or such other period specified by the Federal  
Highway Administration or by the Director, Office of Federal Contract Compliance, U.S. Department of  
Labor.

The above certification is part of the Proposal. Sign below to acknowledge understanding.

**Proposer Signature:** \_\_\_\_\_

**Form 4**

The Proposer/Operator shall list the name and address of each proposed subcontractor, to whom the Proposer/Operator expects to subcontract portions of the work. **(If no Subcontracts are proposed please indicate by entering "DNA" (Does Not Apply))**

**LIST OF PROPOSED SUBCONTRACTORS/Sub-CONSULTANTS (DBE's to also be reflected on Form 9)**  
Add sheets if necessary

Company: \_\_\_\_\_  
Address: \_\_\_\_\_ City, State, Zip: \_\_\_\_\_  
Telephone: (\_\_\_\_) \_\_\_\_\_ Fax: (\_\_\_\_) \_\_\_\_\_ email: \_\_\_\_\_  
Certified DBE? \_ Yes \_\_\_\_\_ No If yes, provide certification # \_\_\_\_\_

Company: \_\_\_\_\_  
Address: \_\_\_\_\_ City, State, Zip: \_\_\_\_\_  
Telephone: (\_\_\_\_) \_\_\_\_\_ Fax: (\_\_\_\_) \_\_\_\_\_ email: \_\_\_\_\_  
Certified DBE? \_ Yes \_\_\_\_\_ No If yes, provide certification # \_\_\_\_\_

Company: \_\_\_\_\_  
Address: \_\_\_\_\_ City, State, Zip: \_\_\_\_\_  
Telephone: (\_\_\_\_) \_\_\_\_\_ Fax: (\_\_\_\_) \_\_\_\_\_ email: \_\_\_\_\_  
Certified DBE? \_ Yes \_\_\_\_\_ No If yes, provide certification # \_\_\_\_\_

Company: \_\_\_\_\_  
Address: \_\_\_\_\_ City, State, Zip: \_\_\_\_\_  
Telephone: (\_\_\_\_) \_\_\_\_\_ Fax: (\_\_\_\_) \_\_\_\_\_ email: \_\_\_\_\_  
Certified DBE? \_ Yes \_\_\_\_\_ No If yes, provide certification # \_\_\_\_\_

**Form 5**

**PUBLIC CONTRACT CODE SECTION 10162 QUESTIONNAIRE  
(Must Check Yes or No)**

In accordance with Public Contract Code Section 10162, the Proposer/Operator shall complete, under penalty of perjury, the following questionnaire:

**QUESTIONNAIRE**

Has the Proposer/Operator, any officer of the Proposer/Operator, or any employee of the Proposer/Operator who has a proprietary interest in the Proposer/Operator, ever been disqualified, removed, or otherwise prevented from proposing on, or completing a federal, state, or local government PROJECT because of a violation of the law or a safety regulation?

Yes \_\_\_\_\_

No \_\_\_\_\_

If the answer is Yes, explain the circumstances in the following space.

**Form 6**

**BUTTE COUNTY ASSOCIATION OF GOVERNMENTS**

**NON-COLLUSION AFFIDAVIT**

**(Title 23, United States Code Section 112 and Public Contract Code 7106)**

In conformance with **Title 23, United States Code, Section 112 and Public Contract Code 7106**, the Proposer/Operator declares that the proposal is not made in the interest of or on behalf of, an undisclosed person, partnership, company, association, organization or corporation; that the proposal is genuine and not collusive or sham; that the Proposer/Operator has not directly or indirectly induced or solicited any other Proposer/Operator to put in a false or sham proposal, and has not directly or indirectly colluded or conspired, connived, or agreed with any Proposer/Operator or anyone else to put in a sham proposal, or that anyone shall refrain from proposing; that the Proposer/Operator has not in any manner, directly or indirectly, sought by agreement, communication, or conference with anyone to fix the proposal price of the Proposer/Operator or any other Proposer/Operator, or to fix any overhead, profit, or cost element of the proposal price, or of that of any other Proposer/Operator, or to secure any advantage against the public body awarding the contract of anyone interested in the proposed contract; that all statements contained in the proposal are true; and, further that the Proposer/Operator has not, directly or indirectly, submitted his or her proposal price or any breakdown thereof, or the contents thereof, or divulged information or data relative thereto, or paid, and will not pay, any fee to any corporation, partnership, company association, organization, proposal, depository, or to any member or agent thereof to effectuate a collusive or sham proposal.

**PUBLIC CONTRACT SECTION 10232 STATEMENT**

In accordance with **Public Contract code Section 10232**, the Proposer/Operator, hereby states under penalty of perjury, that no more than one final appealable finding of contempt of court by a federal court has been issued against the Proposer/Operator within the immediately preceding two-year period because of the Proposer/Operator's failure to comply with an order of a federal court which orders the Consultant to comply with an order of the National Labor Relations Board.

Note: The Equal Employment Opportunity Certification (Form 1), the above statement, the Questionnaire (Form 3) and this, this statement and Non-Collusion Affidavit are part of the proposal.

Proposer are cautioned that making a false certification may subject the certifier to criminal prosecution. The above certification is part of the Proposal. Sign below to acknowledge understanding.

**Proposer Signature:** \_\_\_\_\_



**Form 7**

**PUBLIC CONTRACT CODE SECTION 10285.1 STATEMENT**

In accordance with Public Contract Code Section 10285.1 (Chapter 376, Stats. 1985), the Proposer/Operator hereby declares under penalty of perjury under the laws of the State of California that the Proposer/Operator has\_\_\_, has not \_\_\_ been convicted within the preceding three years of any offenses referred to in that section, including any charge of fraud, bribery, collusion, conspiracy, or any other act in violation of any state or federal antitrust law in connection with the proposing upon, award of, or performance of, any public works contract, as defined in Public Contract Code Section 1101, with any public entity, as defined in Public Contract Code Section 1100, including the Regents of the University of California or the Trustees of the California State University. The term "Proposer/Operator" is understood to include any partner, member, officer, director, responsible managing officer, or responsible managing employee thereof, as referred to in Section 10285.1.

Note: The Proposer/Operator must place a check mark after "has" or "has not" in one of the blank spaces provided.

The above Statement is part of the Proposal. Proposer are cautioned that making a false certification may subject the certifier to criminal prosecution. Sign below to acknowledge understanding.

**Proposer Signature:** \_\_\_\_\_

## Form 8

### Proposer Certification Clauses and Proposal Signature

#### PROPOSER/OPERATOR CERTIFICATION CLAUSES

1. STATEMENT OF COMPLIANCE: Consultant has, unless exempted, complied with the nondiscrimination program requirements. (GC 12990 (a-f) and CCR, Title 2, Section 8103) (Not applicable to public entities.)
2. DRUG-FREE WORKPLACE REQUIREMENTS: Consultant will comply with the requirements of the Drug-Free Workplace Act of 1990 and will provide a drug-free workplace by taking the following actions:
  - a. Publish a statement notifying employees that unlawful manufacture, distribution, dispensation, possession or use of a controlled substance is prohibited and specifying actions to be taken against employees for violations.
  - b. Establish a Drug-Free Awareness Program to inform employees about:
    - 1) the dangers of drug abuse in the workplace;
    - 2) the person's or organization's policy of maintaining a drug-free workplace;
    - 3) any available counseling, rehabilitation and employee assistance programs;
    - 4) penalties that may be imposed upon employees for drug abuse violations.
  - c. Every employee who works on the proposed Agreement will:
    - 1) receive a copy of the company's drug-free workplace policy statement; and,
    - 2) agree to abide by the terms of the company's statement as a condition of employment on the Agreement.

Failure to comply with these requirements may result in suspension of payments under the Contract or termination of the Contract or both and Consultant may be ineligible for award of any future BCAG agreements if BCAG determines that any of the following has occurred: (1) the Consultant has made a false certification or has violated the certification by failing to carry out the requirements as noted above (GC 8350 et seq.).

3. NATIONAL LABOR RELATIONS BOARD CERTIFICATION: Consultant certifies that no more than one (1) final unappealable finding of contempt of court by a Federal court has been issued against Consultant within the immediately preceding two-year period because of Consultant's failure to comply with an order of a Federal court, which orders Consultant to comply with an order of the National Labor Relations Board. (PCC 10296) (Not applicable to public entities.)
4. UNION ORGANIZING: Consultant hereby certifies that no request for reimbursement, or payment under this agreement, will seek reimbursement for costs incurred to assist, promote or deter union organizing.
5. CONTRACTS FOR LEGAL SERVICES \$50,000 OR MORE- PRO BONO REQUIREMENT: Consultant hereby certifies that contractor will comply with the requirements of Section 6072 of the Business and Professions Code, effective January 1, 2003.

## Form 8 (Cont'd)

### DOING BUSINESS WITH BCAG

**The following laws apply to persons or entities doing business in the State of California.**

1. LABOR CODE/WORKERS' COMPENSATION: Consultant needs to be aware of the provisions which require every employer to be insured against liability for Worker's Compensation or to undertake self-insurance in accordance with the provisions, and Contractor affirms to comply with such provisions before commencing the performance of the work of this Agreement. (Labor Code Section 3700)
2. AMERICANS WITH DISABILITIES ACT: Consultant assures the State that it complies with the Americans with Disabilities Act (ADA) of 1990, which prohibits discrimination on the basis of disability, as well as all applicable regulations and guidelines issued pursuant to the ADA. (42 U.S.C. 12101 et seq.)
3. CONTRACTOR NAME CHANGE: An amendment is required to change the Consultant 's name as listed on this Agreement. Upon receipt of legal documentation of the name change BCAG will process the amendment. Payment of invoices presented with a new name cannot be paid prior to approval of said amendment.
4. CORPORATE QUALIFICATIONS TO DO BUSINESS IN CALIFORNIA:
  - a. When agreements are to be performed in the state by corporations, the contracting agencies will be verifying that the Consultant is currently qualified to do business in California in order to ensure that all obligations due to BCAG are fulfilled.
  - b. "Doing business" is defined in R&TC Section 23101 as actively engaging in any transaction for the purpose of financial or pecuniary gain or profit. Although there are some statutory exceptions to taxation, rarely will a corporate Consultant performing within the state not be subject to the franchise tax.
  - c. Both domestic and foreign corporations (those incorporated outside of California) must be in good standing in order to be qualified to do business in California. Agencies will determine whether a corporation is in good standing by calling the Office of the Secretary of State.
5. RESOLUTION: A county, city, district, or other local public body must provide the State with a copy of a resolution, order, motion, or ordinance of the local governing body which by law has authority to enter into an agreement, authorizing execution of the agreement.
6. AIR OR WATER POLLUTION VIOLATION: Under the State laws, the Consultant shall not be: (1) in violation of any order or resolution not subject to review promulgated by the State Air Resources Board or an air pollution control district; (2) subject to cease and desist order not subject to review issued pursuant to Section 13301 of the Water Code for violation of waste discharge requirements or discharge prohibitions; or (3) finally determined to be in violation of provisions of federal law relating to air or water pollution.
7. PAYEE DATA RECORD FORM STD. 204: This form must be completed by all contractors that are not another state agency or other government entity.

**Form 8 (Cont'd)**

*By my signature on this proposal I certify, under penalty of perjury under the laws of the state of California that the included questionnaire and statements of Public Contract Code Sections 10162, 10232 and 10285.1 are true and correct and that the Proposer/Operator has complied with the requirements of Section 8103 of the Fair Employment and Housing Commission Regulations (Chapter 5, Title 2 of the California administrative Code). By my signature on this proposal I Further certify, under penalty of perjury under the laws of the State of California and the United States of America, that the Non-collusion Affidavit required by Title 23 United States Code, Section 112 and Public Contract Code Section 7106; and the Title 49 code of Federal Regulations, Part 29 Debarment and Suspension certification are true and correct. (Forms 1-8)*

The undersigned hereby certify and declare under penalty of perjury that the foregoing is true and correct and that I am duly authorized to legally bind the prospective Proposer/Operator to the clauses listed above. This certification is made under the laws of the State of California. The **undersigned is duly authorized to certify that the contents of the technical proposal are true and accurate and the commitment to perform the requested services is certified for a 90 day period.**

<i>Proposer/Operator Firm Name (Printed)</i>		<i>Federal ID Number</i>
<i>By (Authorized Signature)</i>		
<i>Printed Name and Title of Person Signing</i>		
<i>Date Executed</i>	<i>Executed in the County of</i>	

*NOTE - If Proposer/Operator is a corporation, the legal name of the corporation shall be set forth above together with the signature of the officer or officers authorized to sign contracts on behalf of the corporation: if Proposer/Operator is a co-partnership, the true name of the firm shall be set forth above together with the signature of the partner or partners authorized to sign contracts in behalf of the co-partnership: and if Proposer/Operator is an individual, his signature shall be placed above. If signature is by an agent other than of an officer of a corporation or a member of a partnership, a power of attorney must be on file with BCAG prior to opening proposals or submitted with the proposal; otherwise, the proposal will be discarded as irregular and unauthorized.*

**Form 9**

**Proposer/Operator-DBE (Consultant Contracts)-Information**

This information shall be provided by the successful Proposer/Operator/Bidder with the award document.

- Preliminary Engr.  
  Studies  
  Environmental Document  
  Prelim Design  
  Professional Services  
 Final Design Right of Way  
 Right of Way Engineering  
 Right of Way Utility Relocation  
 Construction  
 Construction Engineering  
 Construction Management  
 Contractor/Transit Services

AGENCY: **Butte County Association of Governments/Butte Regional Transit**      LOCATION: **Chico, Butte County**  
 PROJECT DESCRIPTION: **Design and Construction of Electric Vehicle Underground Infrastructure for BRT**

BCAG Work Element Number:

FEDERAL-AID PROJECT NUMBER:

TOTAL CONTRACT AMOUNT: **DNA.**

FEDERAL SHARE (For local agency to complete): **DNA**

PROPOSAL/BID DATE:

PROPOSER/OPERATOR'S/BIDDER'S

NAME: \_\_\_\_\_

CONTRACT ITEM NO.	ITEM OF WORK AND DESCRIPTION OR SERVICES TO BE SUBCONTRACTED OR MATERIALS TO BE PROVIDED <sup>2</sup>	DBE Cert. No. AND EXPIRATION DATE	NAME OF DBEs <sup>1</sup> (Must be certified on the date bids are opened - include DBE address and phone number)	DOLLAR AMOUNT DBE

<p><b>IMPORTANT:</b> Identify all DBE firms being claimed for credit, regardless of tier. Copies of the DBE quotes are helpful. Names of the First-Tier DBE Subcontractors and their respective item(s) of work listed above shall be consistent with the names and items of work in the "List of Subcontractors" submitted with your bid pursuant to the Subcontractors Listing Law and the Special Provisions.</p> <p>1. Enter DBE prime and subcontractors certification number. Prime contractors shall indicate all work to be performed by DBEs including work performed by its own DBE forces.</p> <p>2. If 100% of item is not to be performed or furnished by DBE, describe exact portion of item to be performed or furnished by DBE.</p>	<p align="center">Total Claimed Participation</p> <p align="right">\$ _____ _____ %</p>
	<p>_____ Signature of Proposer/Operator</p> <p>_____ Date (Area Code) Tel. No.</p> <p>_____ Person to Contact (Please Type or Print)</p>

Form 9 (Cont'd)

**INSTRUCTIONS - PROPOSER/OPERATOR/BIDDER-DBE (CONSULTANT CONTRACTS) INFORMATION FORM  
(Revised 8/20)**

The form requires specific information regarding the consultant contract: Agency, Location, PROJECT Descriptions, Contract Number (assigned by local agency), Federal Aid PROJECT Number (if available and required and as assigned by Local Agency or FTA), Total Dollar Contract Amount, Proposal/Bid Date, and **Proposer/Operator's/Bidder's Name .**

**The form has a column for the Contract Item Number (or Item No's) and Item of Work and Description or Services to be Subcontracted or Materials to be provided by DBEs. The DBE should provide a certification number to the Contractor. Notify the Contractor in writing with the date of the decertification if their status should change during the course of the contract. The form has a column for the Names of DBE certified contractors to perform the work (include DBE address and phone number).**

**There is a column for the total DBE dollar amount. Enter the Total Claimed DBE Participation dollars and percentage of items of work submitted with your proposal/bid pursuant to the Contract Provisions. (If 100% of item is not to be performed or furnished by the DBE, describe exact portion of time to be performed or furnished by the DBE.)**

**Form 9 - must be signed and dated by the person proposing/bidding. At a minimum this form must be returned and is a required element prior to any contract award. Also list a phone number in the space provided and print the name of the person to contact.**

Note: If no DBE participation is to be claimed or is unknown at the time of proposal submittal, indicate this is the box titled "Total Claimed participation" as either "0" for no participation claimed or "UK" for unknown at this time.

---

**DBE INFORMATION - GOOD FAITH EFFORTS (REQUIRED IF GOAL NOT MET)**

Federal-aid Project No. \_\_\_\_\_ Bid Opening Date \_\_\_\_\_

The \_\_\_\_\_ (City/County of) \_\_\_\_\_ established a Disadvantaged Business Enterprise (DBE) goal of \_\_\_\_\_% for this project. The information provided herein shows that a good faith effort was made.

Lowest, second lowest and third lowest bidders shall submit the following information to document adequate good faith efforts. Note: If the goal is met, this form is not required with submittal of Package A. *However, bidders are cautioned to maintain the following information even if the "Proposer/Operator DBE Commitment" form indicates that the bidder has met the DBE goal. This will protect the bidder's eligibility for award of the contract if the administering agency determines that the bidder failed to meet the goal for various reasons, e.g., a DBE firm was not certified at bid opening, or the bidder made a mathematical error.*

Submittal of only the "Local Agency Bidder DBE Commitment" form may not provide sufficient documentation to demonstrate that adequate good faith efforts were made.

The following items are listed in the Section entitled "Submission of DBE Commitment" of the Special Provisions:

- A. The names and dates of each publication in which a request for DBE participation for this project was placed by the bidder (please attach copies of advertisements or proofs of publication):

<u>Publications</u>	<u>Dates of Advertisement</u>
_____	_____
_____	_____
_____	_____

- B. The names and dates of written notices sent to certified DBEs soliciting bids for this project and the dates and methods used for following up initial solicitations to determine with certainty whether the DBEs were interested (please attach copies of solicitations, telephone records, fax confirmations, etc.):

<u>Names of DBEs Solicited</u>	<u>Date of Initial Solicitation</u>	<u>Follow Up Methods and Dates</u>
_____	_____	_____
_____	_____	_____
_____	_____	_____
_____	_____	_____
_____	_____	_____
_____	_____	_____

C. The items of work which the bidder made available to DBE firms including, where appropriate, any breaking down of the contract work items (including those items normally performed by the bidder with its own forces) into economically feasible units to facilitate DBE participation. It is the bidder's responsibility to demonstrate that sufficient work to facilitate DBE participation was made available to DBE firms.

Items of Work	Bidder Normally Performs Item (Y/N)	Breakdown of Items	Amount (\$)	Percentage Of Contract

D. The names, addresses and phone numbers of rejected DBE firms, the reasons for the bidder's rejection of the DBEs, the firms selected for that work (please attach copies of quotes from the firms involved), and the price difference for each DBE if the selected firm is not a DBE:

Names, addresses and phone numbers of rejected DBEs and the reasons for the bidder's rejection of the DBEs:

---



---



---



---

Names, addresses and phone numbers of firms selected for the work above:

---



---



---



---

E. Efforts made to assist interested DBEs in obtaining bonding, lines of credit or insurance, and any technical assistance or information related to the plans, specifications and requirements for the work which was provided to DBEs:

---



---



---



---



F. Efforts made to assist interested DBEs in obtaining necessary equipment, supplies, materials or related assistance or services, excluding supplies and equipment the DBE subcontractor purchases or leases from the prime contractor or its affiliate:

---

---

---

---

G. The names of agencies, organizations or groups contacted to provide assistance in contacting, recruiting and using DBE firms (please attach copies of requests to agencies and any responses received, i.e., lists, Internet page download, etc.):

Name of Agency/Organization	Method/Date of Contact	Results
<hr/>		
<hr/>		

H. Any additional data to support a demonstration of good faith efforts (use additional sheets if necessary):

---

---

**NOTE:** USE ADDITIONAL SHEETS OF PAPER IF NECESSARY.

## Form 9A

### Notice to Proposer Disadvantaged Business Enterprise Information

#### NOTICE TO PROPOSER/BIDDERS DISADVANTAGED BUSINESS ENTERPRISE INFORMATION

**(Note: Portions of all Form 9A may not apply for all agreements dependent upon scope of services required)**

#### 1. TERMS AS USED IN THIS DOCUMENT

- The term “Disadvantaged Business Enterprise” or “DBE” means a for-profit small business concern as defined in Title 49, Part 26.5, Code of Federal Regulations (CFR).
- The term “bidder” also means “Proposer/Operator” or “offerer.”
- The term “Agreement” also means “Contract.”
- Agency also means the local entity entering into this contract with the Contractor or Consultant.
- The term “Small Business” or “SB” is as defined in 49 CFR 26.65.

#### 2. AUTHORITY AND RESPONSIBILITY

- A. DBEs and other small businesses are strongly encouraged to participate in the performance of Agreements financed in whole or in part with federal funds (See 49 CFR 26, “Participation by Disadvantaged Business Enterprises in Department of Transportation Financial Assistance Programs”). The Contractor should ensure that DBEs and other small businesses have the opportunity to participate in the performance of the work that is the subject of this solicitation and should take all necessary and reasonable steps for this assurance. The bidder/Proposer/Operator shall not discriminate on the basis of race, color, national origin, or sex in the award and performance of subcontracts.
- B. Bidders/Proposer are encouraged to use services offered by financial institutions owned and controlled by DBEs.

#### 3. SUBMISSION OF DBE INFORMATION

A “Local Agency Proposer/Operator/Bidder-DBE (Consultant Contracts)-Information” form will be included in the Agreement documents to be executed by the successful bidder. The purpose of the form is to collect data required under 49 CFR 26. Even if no DBE participation will be reported, the successful bidder must execute and return the form.

#### 4. DBE PARTICIPATION GENERAL INFORMATION

It is the bidder’s responsibility to be fully informed regarding the requirements of 49 CFR, Part 26, and the Department’s DBE program developed pursuant to the regulations. Particular attention is directed to the following:

- A. A DBE must be a small business firm defined pursuant to 13 CFR 121 and be certified through the California Unified Certification Program (CUCP).
- B. A certified DBE may participate as a prime contractor, subcontractor, joint venture partner, as a vendor of material or supplies, or as a trucking company.
- C. A DBE joint venture partner must be responsible for specific contract items of work or clearly defined portions thereof. Responsibility means actually performing, managing and supervising the work with its own forces. The DBE joint venture partner must share in the capital contribution, control, management, risks and profits of the joint venture commensurate with its ownership interest.

## Form 9A (cont'd)

- D. A DBE must perform a commercially useful function pursuant to 49 CFR 26.55; that is, a DBE firm must be responsible for the execution of a distinct element of the work and must carry out its responsibility by actually performing, managing and supervising the work.
- E. The bidder (prime contractor) shall list only one subcontractor for each portion of work as defined in their bid/proposal and all DBE subcontractors should be listed in the bid/cost proposal list of subcontractors.
- F. A prime contractor who is a certified DBE is eligible to claim all of the work in the Agreement toward the DBE participation except that portion of the work to be performed by non-DBE subcontractors.

### 5. RESOURCES

- A. The CUCP database includes the certified DBEs from all certifying agencies participating in the CUCP. If you believe a firm is certified that cannot be located on the database, please contact the Caltrans Office of Certification toll free number 1-866-810-6346 for assistance. Bidder/Proposer/Operator may call (916) 440-0539 for web or download assistance.

- B. Access the CUCP database from the Department of Transportation, Civil Rights, Business Enterprise Program website at: <http://www.dot.ca.gov/hq/bep/>.

Click on the link in the left menu titled Find a Certified Firm

Click on Query Form link, located in the first sentence

Click on Certified DBE's (UCP) located on the first line in the center of the page

Click on Click To Access DBE Query Form

Searches can be performed by one or more criteria

Follow instructions on the screen

“Start Search,” “Requery,” “Civil Rights Home,” and “Caltrans Home” links are located at the bottom of the query form

- C. How to Obtain a List of Certified DBEs without Internet Access

**DBE Directory:** If you do not have Internet access, Caltrans also publishes a directory of certified DBE firms extracted from the on-line database. A copy of the directory of certified DBEs may be ordered from the Caltrans Division of Procurement and Contracts/Material and Distribution Branch/Publication Unit, 1900 Royal Oaks Drive, Sacramento, CA 95815, Telephone: (916) 445-3520.

### 6. WHEN REPORTING DBE PARTICIPATION, MATERIAL OR SUPPLIES PURCHASED FROM DBEs MAY COUNT AS FOLLOWS:

- A. If the materials or supplies are obtained from a DBE manufacturer, one hundred percent of the cost of the materials or supplies will count toward the DBE participation. A DBE manufacturer is a firm that operates or maintains a factory, or establishment that produces on the premises, the materials, supplies, articles, or equipment required under the Agreement and of the general character described by the specifications.
- B. If the materials or supplies purchased from a DBE regular dealer, count sixty percent of the cost of the materials or supplies toward DBE participation. A DBE regular dealer is a firm that owns, operates or maintains a store, warehouse, or other establishment in which the materials, supplies, articles or equipment of the general character described by the specifications and required under the Agreement are bought, kept in stock, and regularly sold or leased to the public in the usual course of business. To be a DBE regular dealer, the firm must be an established, regular business that engages, as its principal business and under its own name, in the purchase and sale or lease of the products in question. A person may be a DBE regular dealer in such bulk items as petroleum products, steel, cement, gravel, stone or asphalt without owning, operating or maintaining a place of business provided in this section.

### Form 9A (cont'd)

- C. If the person both owns and operates distribution equipment for the products, any supplementing of regular dealers' own distribution equipment shall be by a long-term lease agreement and not an ad hoc or Agreement-by-Agreement basis. Packagers, brokers, manufacturers' representatives, or other persons who arrange or expedite transactions are not DBE regular dealers within the meaning of this section.
- D. Materials or supplies purchased from a DBE, which is neither a manufacturer nor a regular dealer, will be limited to the entire amount of fees or commissions charged for assistance in the procurement of the materials and supplies, or fees or transportation charges for the delivery of materials or supplies required on the job site, provided the fees are reasonable and not excessive as compared with fees charged for similar services.

#### **7. WHEN REPORTING DBE PARTICIPATION, PARTICIPATION OF DBE TRUCKING COMPANIES MAY COUNT AS FOLLOWS:**

- A. The DBE must be responsible for the management and supervision of the entire trucking operation for which it is responsible.
- B. The DBE must itself own and operate at least one fully licensed, insured and operational truck used on the Agreement.
- C. The DBE receives credit for the total value of the transportation services it provides on the Agreement using trucks it owns, insures, and operates using drivers it employs.
- D. The DBE may lease trucks from another DBE firm, including an owner-operator who is certified as a DBE. The DBE who leases trucks from another DBE receives credit for the total value of the transportation services the lessee DBE provides on the Agreement.
- E. The DBE may also lease trucks from a non-DBE firm, including an owner-operator. The DBE who leases trucks from a non-DBE is entitled to credit only for the fee or commission it receives as a result of the lease arrangement. The DBE does not receive credit for the total value of the transportation services provided by the lessee, since these services are not provided by the DBE.
- F. For the purposes of this Section D, a lease must indicate that the DBE has exclusive use and control over the truck. This does not preclude the leased truck from working for others during the term of the lease with the consent of the DBE, as long as the lease gives the DBE absolute priority for use of the leased truck. Leased trucks must display the name and identification number of the DBE.

## Form 9B

### Standard Agreement for Subcontractor/DBE Participation

**(Note: Portions or all of Form 9B may not apply for all agreements dependent upon scope of services required)**

#### 1. Subcontractors

- A. Nothing contained in this Agreement or otherwise, shall create any contractual relation between the Agency and any subcontractors, and no subcontract shall relieve the Contractor of his/her responsibilities and obligations hereunder. The Contractor agrees to be as fully responsible to the Agency for the acts and omissions of its subcontractors and of persons either directly or indirectly employed by any of them as it is for the acts and omissions of persons directly employed by the Contractor. The Contractor's obligation to pay its subcontractors is an independent obligation from the Agency's obligation to make payments to the Contractor.
- B. Any subcontract in excess of \$25,000, entered into as a result of this Agreement, shall contain all the provisions stipulated in this Agreement to be applicable to subcontractors.
- C. Contractor shall pay its subcontractors within ten (10) calendar days from receipt of each payment made to the Contractor by the Agency.
- D. Any substitution of subcontractors must be approved in writing by the Agency's Contract Manager in advance of assigning work to a substitute subcontractor.

#### 2. Disadvantaged Business Enterprise (DBE) Participation

- A. This Agreement is subject to 49 CFR, Part 26 entitled "Participation by Disadvantaged Business Enterprises in Department of Transportation Financial Assistance Programs." Proposer who obtain DBE participation on this contract will assist Caltrans in meeting its federally mandated statewide overall DBE goal.
- B. If the contract has an underutilized DBE (UDBE) goal, the Consultant must meet the UDBE goal by committing UDBE participation or document a good faith effort to meet the goal. If a UDBE subconsultant is unable to perform, the Consultant must make a good faith effort to replace him/her with another UDBE subconsultant, if the goal is not otherwise met. A UDBE is a firm meeting the definition of a DBE as specified in 49 CFR and is one of the following groups: African Americans, Native Americans, Asian-Pacific Americans, or Women.
- C. DBEs and other small businesses, as defined in 49 CFR, Part 26 are encouraged to participate in the performance of agreements financed in whole or in part with federal funds. The Consultant, sub-recipient or subconsultant shall not discriminate on the basis of race, color, national origin, or sex in the performance of this Agreement. The Consultant shall carry out applicable requirements of 49 CFR, Part 26 in the award and administration of US DOT- assisted agreements. Failure by the Consultant to carry out these requirements is a material breach of this Agreement, which may result in the termination of this Agreement or such other remedy as the recipient deems appropriate.
- D. Any subcontract entered into as a result of this Agreement shall contain all of the provisions of this section.

### **3. Performance of DBE Consultant and other DBE Subconsultants/Suppliers**

A DBE performs a commercially useful function when it is responsible for execution of the work of the Agreement and is carrying out its responsibilities by actually performing, managing, and supervising the work involved. To perform a commercially useful function, the DBE must also be responsible with respect to materials and supplies used on the Agreement, for negotiating price, determining quality and quantity, ordering the material, and installing (where applicable) and paying for the material itself. To determine whether a DBE is performing a commercially useful function, evaluate the amount of work subcontracted, industry practices; whether the amount the firm is to be paid under the Agreement is commensurate with the work it is actually performing; and other relevant factors.

A DBE does not perform a commercially useful function if its role is limited to that of an extra participant in a transaction, Agreement, or project through which funds are passed in order to obtain the appearance of DBE participation. In determining whether a DBE is such an extra participant, examine similar transactions, particularly those in which DBEs do not participate.

If a DBE does not perform or exercise responsibility for at least 30 percent of the total cost of its Agreement with its own work force, or the DBE subcontracts a greater portion of the work of the Agreement than would be expected on the basis of normal industry practice for the type of work involved, it will be presumed that it is not performing a commercially useful function.

### **4. Prompt Payment of Funds Withheld to Subcontractors**

The Agency shall hold retainage from the prime consultant and shall make prompt and regular incremental acceptances of portions, as determined by the Agency, of the contract work, and pay retainage to the prime contractor based on these acceptances. The prime consultant, or subconsultant, shall return all monies withheld in retention from a subconsultant within 30 days after receiving payment for work satisfactorily completed and accepted including incremental acceptances of portions of the contract work by the agency. Federal law (49 CFR26.29) requires that any delay or postponement of payment over 30 days may take place only for good cause and with the agency's prior written approval. Any violation of this provision shall subject the violating prime consultant or subconsultant to the penalties, sanctions and other remedies specified in Section 7108.5 of the Business and Professions Code. These requirements shall not be construed to limit or impair any contractual, administrative, or judicial remedies, otherwise available to the prime consultant or subconsultant in the event of a dispute involving late payment or nonpayment by the prime contractor, deficient subconsultant performance, or noncompliance by a subcontractor. This provision applies to both DBE and non-DBE prime consultant and subconsultants.

Any subcontract entered into as a result of this Agreement shall contain all of the provisions of this section.

### **5. DBE Records**

- A. The Consultant shall maintain records of materials purchased and/or supplied from all subcontracts entered into with certified DBEs. The records shall show the name and business address of each DBE or vendor and the total dollar amount actually paid each DBE or vendor, regardless of tier. The records shall show the date of payment and the total dollar figure paid to all firms. DBE prime consultants shall also show the date of work performed by their own forces along with the corresponding dollar value of the work.
- B. Upon completion of the Agreement, a summary of these records shall be prepared and submitted on the form entitled, "Final Report-Utilization of Disadvantaged Business Enterprise (DBE), First-Tier Subcontractors," CEM-2402F (Exhibit 17-F, Chapter 17, of the LAPM), certified correct by the Consultant

or the Consultant's authorized representative and shall be furnished to the Contract Manager with the final invoice. Failure to provide the summary of DBE payments with the final invoice will result in 25% of the dollar value of the invoice being withheld from payment until the form is submitted. The amount will be returned to the Consultant when a satisfactory "Final Report-Utilization of Disadvantaged Business Enterprises (DBE), First-Tier Subcontractors" is submitted to the Contract Manager.

- 1) Prior to the fifteenth of each month, the Consultant shall submit documentation to the Agency's Contract Manager showing the amount paid to DBE trucking companies. The Consultant shall also obtain and submit documentation to the Agency's Contract Manager showing the amount paid by DBE trucking companies to all firms, including owner-operators, for the leasing of trucks. If the DBE leases trucks from a non-DBE, the Consultant may count only the fee or commission the DBE receives as a result of the lease arrangement.
- 2) The Consultant shall also submit to the Agency's Contract Manager documentation showing the truck number, name of owner, California Highway Patrol CA number, and if applicable, the DBE certification number of the truck owner for all trucks used during that month. This documentation shall be submitted on the Caltrans' Monthly DBE Trucking Verification, CEM-2404(F) form provided to the Consultant by the Agency's Contract Manager.

## **6. DBE Certification and Decertification Status**

If a DBE subconsultant is decertified during the life of the Agreement, the decertified subconsultant shall notify the Consultant in writing with the date of decertification. If a subconsultant becomes a certified DBE during the life of the Agreement, the subconsultant shall notify the Consultant in writing with the date of certification. Any changes should be reported to the Agency's Contract Manager within 30 days

**Materials or supplies purchased from DBEs will count towards DBE credit, and if a DBE is also a UDBE, purchases will count towards the UDBE goal under the following conditions:**

- A. If the materials or supplies are obtained from a DBE manufacturer, 100 % of the cost of the materials or supplies will count toward the DBE participation. A DBE manufacturer is a firm that operates or maintains a factory or establishment that produces on the premises the materials, supplies, articles, or equipment required under the Agreement and of the general character described by the specifications.
- B. If the materials or supplies purchased from a DBE regular dealer, count 60 % of the cost of the materials or supplies toward DBE goals. A regular dealer is a firm that owns, operates or maintains a store, warehouse, or other establishment in which the materials, supplies, articles or equipment of the general character described by the specifications and required under the Agreement, are bought, kept in stock, and regularly sold or leased to the public in the usual course of business. To be a regular dealer, the firm must be an established, regular business that engages, as its principal business and under its own name, in the purchase and sale or lease of the products in question. A person may be a regular dealer in such bulk items as petroleum products, steel, cement, gravel, stone or asphalt without owning, operating or maintaining a place of business provided in this section.
- C. If the person both owns and operates distribution equipment for the products, any supplementing of regular dealers' own distribution equipment, shall be by a long-term lease agreement and not an ad hoc or Agreement-by-Agreement basis. Packagers, brokers, manufacturers' representatives, or other persons who arrange or expedite transactions are not regular dealers within the meaning of this section.

Materials or supplies purchased from a DBE, which is neither a manufacturer nor a regular dealer, will be limited to the entire amount of fees or commissions charged for assistance in the procurement of the materials and supplies, or fees or transportation charges for the delivery of materials or supplies required on the job site, provided the fees are reasonable and not excessive as compared with fees charged for similar services.

**Form 10**  
**Current Client References**

Proposer by its signature below, certifies that the following references supplied to other clients over the last seven (7) years (use additional pages as necessary): (A minimum of 5 are required)

	Agency Name:	Contact Name and Phone	Year
1.	_____	_____	_____
2.	_____	_____	_____
3.	_____	_____	_____
4.	_____	_____	_____
5.	_____	_____	_____

Signature: \_\_\_\_\_  
Name: \_\_\_\_\_  
Date: \_\_\_\_\_  
Company Name: \_\_\_\_\_  
Title: \_\_\_\_\_



**Form 11**

**Addenda Acknowledgment**

\_\_\_\_\_ (Name of CONTRACTOR) acknowledges it has received and read the following Addenda:

Addendum # \_\_\_\_\_ Signature \_\_\_\_\_

Addendum # \_\_\_\_\_ Signature \_\_\_\_\_

Addendum # \_\_\_\_\_ Signature \_\_\_\_\_

Addendum # \_\_\_\_\_ Signature \_\_\_\_\_

Addendum # \_\_\_\_\_ Signature \_\_\_\_\_

Addendum # \_\_\_\_\_ Signature \_\_\_\_\_

SIGNATURE \_\_\_\_\_ DATE \_\_\_\_\_

TITLE \_\_\_\_\_ COMPANY NAME \_\_\_\_\_

**PROPOSAL SUBMITTAL REQUIRED FORMS – PACKAGE B**

**EXHIBIT 10-K CONSULTANT ANNUAL CERTIFICATION OF  
INDIRECT COSTS AND FINANCIAL MANAGEMENT SYSTEM**

*(Note: If a Safe Harbor Indirect Cost Rate is approved, this form is not required.)*

**Consultant's Full Legal Name:** \_\_\_\_\_

**Important:** Consultant means the individual or consultant providing engineering and design related services as a party of a contract with a recipient or sub-recipient of Federal assistance. Therefore, the Indirect Cost Rate(s) shall not be combined with its parent company or subsidiaries.

**Indirect Cost Rate:**

Combined Rate \_\_\_\_\_ % **OR**

Home Office Rate \_\_\_\_\_ % and Field Office Rate (if applicable) \_\_\_\_\_ %

Facilities Capital Cost of Money \_\_\_\_\_ % (if applicable)

**Fiscal period \*** \_\_\_\_\_

\* Fiscal period is annual one year applicable accounting period that the Indirect Cost Rate was developed (not the contract period). The Indirect Cost Rate is based on the consultant's one-year applicable accounting period for which financial statements are regularly prepared by the consultant.

I have reviewed the proposal to establish an Indirect Cost Rate(s) for the **fiscal period** as specified above and have determined to the best of my knowledge and belief that:

- All costs included in the cost proposal to establish the indirect cost rate(s) are allowable in accordance with the cost principles of the Federal Acquisition Regulation (FAR) 48, Code of Federal Regulations (CFR), Chapter 1, Part 31 (48 CFR Part 31);
- The cost proposal does not include any costs which are expressly unallowable under the cost principles of 48 CFR Part 31;
- The accounting treatment and billing of prevailing wage delta costs are consistent with our prevailing wage policy as either direct labor, indirect costs, or other direct costs on all federally- funded A&E Consultant Contracts.
- All known material transactions or events that have occurred subsequent to year-end affecting the consultant's ownership, organization, and indirect cost rates have been disclosed as of the date of this certification.

**Financial Management System:**

Our labor charging, job costing, and accounting systems meet the standards for financial reporting, accounting records, and internal control adequate to demonstrate that costs claimed have been incurred, appropriately accounted for, are allocable to the contract, and comply with the federal requirements as set forth in [Title 23 United States Code \(U.S.C.\) Section 112\(b\)\(2\)](#); [48 CFR Part 31.201-2\(d\)](#); [23 CFR, Chapter 1, Part 172.11\(a\)\(2\)](#); and all applicable state and federal rules and regulations.

Our financial management system has the following attributes:

- Account numbers identifying allowable direct, indirect, and unallowable cost accounts;
- Ability to accumulate and segregate allowable direct, indirect, and unallowable costs into separate cost accounts;

- Ability to accumulate and segregate allowable direct costs by project, contract and type of cost;
- Internal controls to maintain integrity of financial management system;
- Ability to account and record costs consistently and to ensure costs billed are in compliance with FAR;
- Ability to ensure and demonstrate costs billed reconcile to general ledgers and job costing system; and
- Ability to ensure costs are in compliance with contract terms and federal and state requirement

**Cost Reimbursements on Contracts:**

I also understand that failure to comply with 48 CFR Part 16.301-3 or knowingly charge unallowable costs to Federal-Aid Highway Program (FAHP) contracts may result in possible penalties and sanctions as provided by the following:

- Sanctions and Penalties - [23 CFR Part 172.11\(c\)\(4\)](#)
- False Claims Act - [Title 31 U.S.C. Sections 3729-3733](#)
- Statements or entries generally - [Title 18 U.S.C. Section 1001](#)
- Major Fraud Act - [Title 18 U.S.C. Section 1031](#)

**All A&E Contract Information:**

- Total participation amount \$\_\_\_\_\_ on all State and FAHP contracts for Architectural & Engineering services that the consultant received in the last three fiscal periods.
- The number of states in which the consultant does business is \_\_\_\_\_.
- Years of consultant’s experience with 48 CFR Part 31 is \_\_\_\_\_.
- Audit history of the consultant’s current and prior years (if applicable)
  - Cognizant ICR Audit                       Local Gov’t ICR Audit                       Caltrans ICR Audit
  - CPA ICR Audit                                       Federal Gov’t ICR Audit

I, the undersigned, certify all of the above to the best of my knowledge and belief and that I have reviewed the Indirect Cost Rate Schedule to determine that any costs which are expressly unallowable under the Federal cost principles have been removed and comply with [Title 23 U.S.C. Section 112\(b\)\(2\)](#), [48 CFR Part 31](#), [23 CFR Part 172](#), and all applicable state and federal rules and regulations. I also certify that I understand that all documentation of compliance must be retained by the consultant. I hereby acknowledge that costs that are noncompliant with the federal and state requirements are not eligible for reimbursement and must be returned to Caltrans.

**Note: Both prime and subconsultants as parties of a contract must complete their own Exhibit 10-K forms. Caltrans will not process local agency’s invoices until a complete Exhibit 10-K form is accepted and approved by Caltrans Audits and Investigations. \*An individual executive or financial officer of the consultant’s or subconsultant’s organization at a level no lower than a Vice President, a Chief Financial Officer, or equivalent, who has authority to represent the financial information used to establish the indirect cost rate.**

Name\*\*: \_\_\_\_\_

Title\*\*: \_\_\_\_\_

Signature: \_\_\_\_\_

Email\*\*: \_\_\_\_\_

# Solar Planset

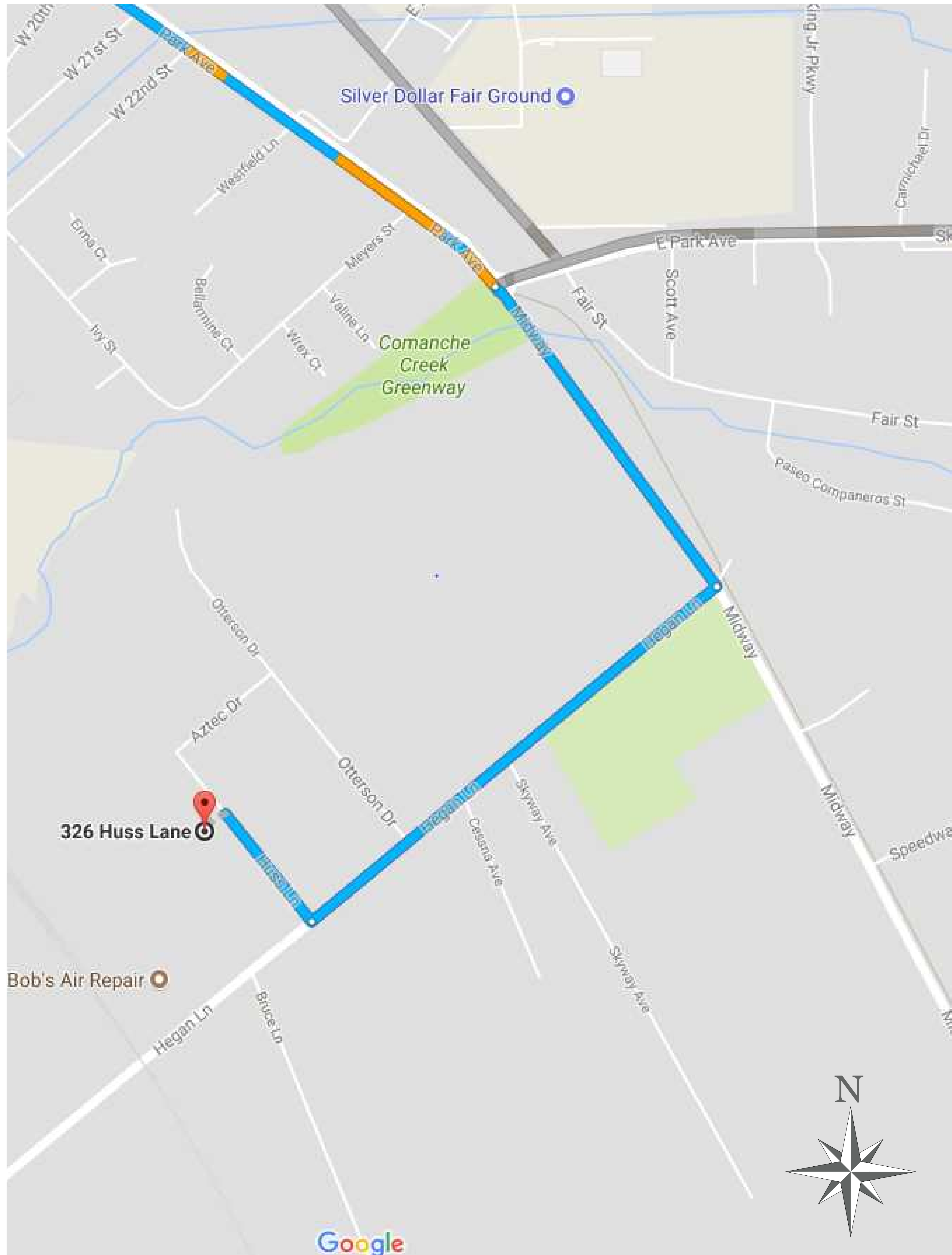

**PROJECT OWNER:**  
 BUTTE COUNTY ASSOCIATION OF GOVERNMENTS  
 326 HUSS LANE  
 CHICO, CA 95928  
 APN# 039-060-142  
 CITY OF CHICO  
 ZONE: ML (LIGHT MANUFACTURING)

**CONTRACTOR:**  
 ALTERNATIVE ENERGY SYSTEMS  
 INC.  
 13620 HIGHWAY 99  
 CHICO, CA 95973  
 CSLB: 853351 C-10, C-46

**SCOPE:**  
 INSTALL SHADE STRUCTURE  
 PHOTOVOLTAIC SOLAR SYSTEM, EV  
 CHARGING STATIONS, DEMOLITION  
 OF EXISTING LIGHTING POSTS &  
 UPDATE ELECTRICAL EQUIPMENT AS  
 NEEDED IN ACCORDANCE WITH ALL  
 APPLICABLE BUILDING CODES  
 SPECIFICALLY REFERENCING THE 2016  
 CALIFORNIA ELECTRICAL CODE USING  
 THE FOLLOWING SPECIFIC  
 EQUIPMENT:

**MODULES:** SUNPOWER  
 (978) SUNPOWER  
 (425.43) KW SYSTEM  
 22,777 SQFT COVERED  
**INVERTER(S):** SMA  
 (11) STP3000TL-US-10  
 (1) STP2400TL-US-10  
 (1) STP1500TL-US-10

**ELECTRICAL ENGINEERING:**

MIKE PECORINO  
 CONSTRUCTION DESIGN SERVICES  
 PO BOX 34051  
 RENO, NV  
 PH# 775-636-0080  
 mpecorino@cds-nv.com

PAGE #	CONTENT
PV-1.0	SCOPE OF WORK
PV-1.1	CODE REFERENCE
PV-2.0	PARCEL SETBACKS
PV-2.1	SITE PLAN
PV-2.2	UNDERGROUND PLAN
PV-2.3	DETAILS
PV-2.4	LIGHTING EV DETAILS
PV-2.5	STRINGING LAYOUT
PV-3.0	ELECTRICAL DIAGRAM
PV-3.1	LIGHTING & EV DIAGRAM
PV-3.2	ELECTRICAL ELEVATION
PV-3.3	LABELING DIAGRAM
PV-4.0	EROSION & SED. CONTROL
PV-4.1	ARCHITECTURAL RENDERING
PV-4.2	ARCHITECTURAL DETAIL

**ATTACHMENTS:** MODULE SPECS  
 INVERTER SPECS  
 WIRE CALCS  
 STRUCTURAL DETAILS  
 STRUCTURAL CALCULATIONS

**BUILDING JURISDICTION:**

CITY OF CHICO  
 BLD. & DEVELOPMENT SERVICES

411 MAIN STREET  
 CHICO, CA 95927  
 OFFICE#: (530) 879-6700  
 www.chico.ca.us/building\_development

13620 HWY 99  
 CHICO, CA 95973  
 PHONE#: (530) 345-6980  
 FAX#: (530) 892-2360  
 info@solarenergyforlife.com



BUTTE COUNTY ASSOCIATION OF GOVERNMENTS  
 326 HUSS LANE  
 CHICO, CA 95920  
 APN# 039-060-142  
 CITY OF CHICO

SCALE: N.T.S.  
 DATE MODIFIED: November 20, 2017  
 DATE CREATED: December 9, 2015  
 DESIGNER: E. TRITTEN  
 CONSULTANT: C. ALMAGUER

ALL WORK SHALL BE IN ACCORDANCE WITH:  
 2016 CALIFORNIA RESIDENTIAL CODE (CRC)  
 2016 CALIFORNIA BUILDING CODE  
 2016 CALIFORNIA FIRE CODE  
 2016 CALIFORNIA ELECTRICAL CODE  
 2016 CALIFORNIA GREEN BUILDING STANDARDS CODE

**ELECTRICAL:**

1. ALL EQUIPMENT SHALL BE LISTED AND LABELED PER RECOGNIZED ELECTRICAL TESTING LABORATORY AN INSTALLED PER THE LISTING REQUIREMENTS AND THE MANUFACTURER'S INSTRUCTIONS.
2. ALL INVERTERS SHALL BE IEEE 929 COMPLIANT AND SHALL BE INSPECTED BY LOCAL UTILITY BEFORE COMMISSIONING, TESTING, AND OPERATION OF THE SYSTEM.
3. ALL OUTDOOR EQUIPMENT SHALL BE MINIMUM NEMA 3R, INCLUDING OUTDOOR MOUNTED TRANSITION BOXES, COMBINER BOXES, AND SWITCHES.
4. ALL EQUIPMENT SHALL BE PROPERLY GROUNDED PER THE REQUIREMENTS OF CEC ART.250,690.
5. CEC. ART. 690.9(A). ALL CIRCUITS CONNECTED TO MORE THAN ONE SOURCE SHALL HAVE OVERCURRENT DEVICES LOCATED SO AS TO PROVIDE OVERCURRENT PROTECTION FROM ALL SOURCES.
6. CEC ART. 690.18. DUE TO THE FACT THAT PV MODULES ARE ENERGIZED WHENEVER THEY ARE EXPOSED TO LIGHT, PV CONTRACTOR SHALL DISABLE THE ARRAY DURING INSTALLATION AND SERVICE BY SHORT CIRCUITING, OPEN CIRCUITING, OR COVERING THE ARRAY WITH AN OPAQUE COVERING.
7. PHOTOVOLTAIC SYSTEM SHALL BACKFEED THE DISTRIBUTION SYSTEM ON SITE PER THE REQUIREMENTS OF CEC ART.690.64(B). ALL BACKFEED BREAKERS SHALL BE IDENTIFIED AS SUCH AND SHALL BE SECURED IN PLACE BY ADDITIONAL FASTENER PER THE REQUIREMENTS OF CEC 408.16(F) (408.36 IN CEC).
8. FALL ARREST PROTECTION PER OSHA REQUIREMENTS SHALL BE PROVIDED FOR ALL ROOF WORK.
9. ALL CONDUCTORS AND TERMINATIONS SHALL BE RATED FOR 75° C MINIMUM.
10. - SEE SHEET PV-3.2 FOR LABEL DIAGRAM
- 11.- SEE SHEET PV-3.2 FOR LABEL DIAGRAM
12. CEC ART. 690.17. EACH AC DISCONNECT SHALL ALSO BE LABELED WITH: "WARNING!-ELECTRICAL SHOCK HAZARD - DO NOT TOUCH TERMINALS. TERMINALS ON BOTH LINE AND LOAD SIZE MAY BE ENERGIZED IN THE OPEN POSITION".
13. DC DISCONNECT AT THE INVERTER WILL BE READILY ACCESSIBLE AFTER THE INSTALLATION IS COMPLETE PER CEC ART. 690.17 WHERE TERMINALS OF THE DISCONNECTING MEANS MAY BE ENERGIZED IN THE OPEN POSITION. PROVIDE A WARNING SIGN OF THE HAZARDS PER CEC ART.690.17
14. CONTRACTOR TO PROVIDE GROUND FAULT PROTECTION FOR ROOF MOUNTED PHOTOVOLTAIC ARRAYS LOCATED ON DWELLINGS PER 2016 CEC ART.690.17.

15. WHERE MORE THAN ONE NOMINAL VOLTAGE SYSTEM EXIST, THE DIFFERENT SYSTEMS SHALL BE IDENTIFIED BY PHASE AND SYSTEM PER CEC ART.210.4D
16. PROVIDE AN ACCESSIBLE DISCONNECT DEVICE THAT IS LOCKABLE IN OPEN POSITION AND IS LOCATED WITHIN 10'-0" OF THE METER PER LOCAL ELECTRICAL UTILITY REGULATIONS.
17. PHOTOVOLTAIC SOURCE CURRENTS MUST BE RATED AT BOTH 125% OF THE PARALLEL MODULE AND AT A CONTINUOUS LOAD OF ANOTHER 125% FOR A TOTAL OF 156% OF THE LOAD.
18. PROVIDE PERMANENT PLAQUE OR DIRECTORY PROVIDING THE LOCATION OF THE SERVICE DISCONNECTING MEANS AND THE PHOTOVOLTAIC SYSTEM DISCONNECT MEANS IF THEY ARE NOT IN THE SAME LOCATION PER CEC ART.690.56.
19. INSTALLATION OF PV PANEL ARRAYS SHOULD RESIST SLIDING AND POP-UP RESULTING FROM SEISMIC EVENTS AND SHOULD COMPLY WITH CBC SECTION 1613A AND ASCE STANDARD 7-05, CHAPTER 13.
20. PV SYSTEM INSTALLER WILL BE RESPONSIBLE FOR FURNISHING AND INSTALLATION OF ALL RELATED EQUIPMENT, CABLES, ADDITIONAL CONDUITS, BOXES WIREWAYS AND OTHER ACCESSORIES NECESSARY FOR COMPLETE AND OPERATIONAL PHOTOVOLTAIC SYSTEMS.
21. PV SYSTEM CONTRACTOR SHALL COORDINATE ALL THE WORK WITH THE ENGINEER, THE CONSTRUCTION MANAGER AND ALL OTHER CONTRACTORS TO ENSURE THAT PV SYSTEM IS INSTALLED AS SPECIFIED IN THESE DRAWINGS.
22. DRAWING IN GENERAL OR DIAGRAMMATIC AND INDICATE GENERAL ARRANGEMENT OF THE EQUIPMENT AND WORK INCLUDED. THE INTENTION OF THE DRAWING IS TO INDICATE SIZE, CAPACITY, APPROXIMATE LOCATION AND GENERAL RELATIONSHIP, BUT NOT EXACT DETAIL OR PHYSICAL PLACEMENT.
23. FIELD VERIFIES EXACT AIC RATING REQUIRED OF THE MAIN SWITCHBOARD FROM LOCAL UTILITY.
24. A PV SYSTEM WITH MULTIPLE INVERTERS, WHERE INVERTERS ARE REMOTELY LOCATED FROM EACH OTHER, WILL HAVE A DIRECTORY CREATED FOR EACH LOCATION. AS PER CEC 690.5(H) AND IN ACCORDANCE WITH CEC 705.10.

**ELECTRICAL SYMBOLS:**

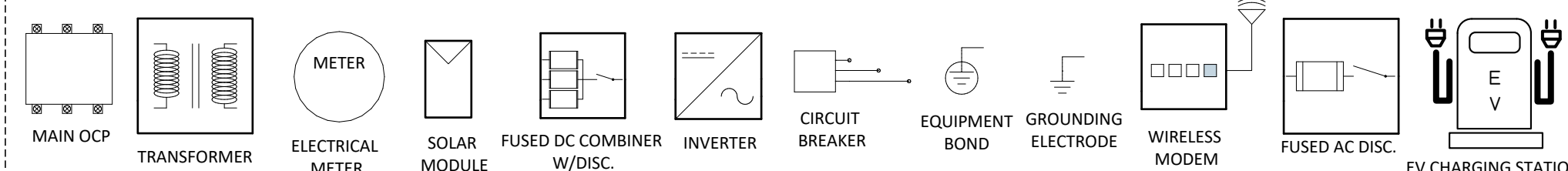

**ABBREVIATIONS:**

P	POLE	(P)	PROPOSED
∅	PHASE	(E)	EXISTING
W	WIRE	NTS	NOT TO SCALE
A	AMPERE	DC	DIRECT CURRENT
AC	ALTERNATING CURRENT	FT	FOOT FEET
AL	ALUMINUM	J-BOX	JUNCTION BOX
AR	AS REQUIRED	M	METER
ART	ARICLE	NA	NOT APPLICABLE
AZ	AZIMUTH	GRND	ELECTRICAL GROUND
BLDG	BUILDING	NEUT	NEUTRAL
CEC	CALIFORNIA ELECTRIC CODE	COND	CONDUIT
EMT	ELECTRICAL METALIC COND	CU	COPPER

**UNDERGROUND ELECTRICAL**

1. AND SERVICES TO CONSTRUCT AND COMPLETE AN UNDERGROUND ELECTRIC SUBSTRUCTURE SYSTEM. THESE INCLUDE BUT NOT LIMITED TO EXCAVATION, SHORING OF EXCAVATION, INSTALLATION OF CONDUITS AND CONCRETE SUBSTRUCTURES, CONCRETE ENCASEMENT, BACKFILLING, COMPACTION OF BACKFILL, PERMANENT RESURFACING, RECONSTRUCTION OF CONCRETE IMPROVEMENTS, DISPOSAL OF CONSTRUCTION DEBRIS AND ALL APPURTENANT WORK.
2. CONTRACTOR SHALL NOTIFY UNDERGROUND SERVICE ALERT (USA) BEFORE COMMENCING WITH ANY EXCAVATIONS. CONTRACTOR SHALL DETERMINE THE EXACT LOCATION OF ALL UNDERGROUND SUBSTRUCTURES OR UTILITIES INCLUDING SERVICE CONNECTIONS AND PROTECT THESE EXISTING SUBSTRUCTURES DURING CONSTRUCTION. ANY DAMAGE DONE BY THE CONTRACTOR TO THESE EXISTING SUBSTRUCTURES WILL BE THE TOTAL RESPONSIBILITY OF THE CONTRACTOR AND THAT THESE DAMAGED SUBSTRUCTURES SHALL BE RESTORED TO THEIR ORIGINAL CONDITION.
3. ALL EXPOSED OR ABOVE GROUND CONDUITS AND SWEEPS SHALL BE SCHEDULE 80. ALL CONDUITS AND SWEEPS SHALL BE INSTALLED AS PER PLAN. ALL CONDUIT SWEEPS, AND BENDS SHALL BE APPROVED PVC PLASTIC SCHEDULE 40. IN ANY CONDUIT RUN THE TOTAL ANGULAR DEGREE OF SWEEPS AND BENDS BETWEEN TWO CONNECTION POINTS SHALL NOT EXCEED 270 DEGREES.
4. ALL CONDUITS INSTALLED SHALL HAVE MINIMUM COVERAGE OF 24" FROM FINISHED GRADE TO TOP OF CONDUIT. ELECTRIC CONDUITS SHALL BE AWAY FROM EXISTING SUBSTRUCTURES OR UTILITIES BY A MINIMUM PARALLEL CLEARANCE OF 12" HORIZONTAL AND 6" VERTICALLY WHEN CROSSING. OTHER UTILITIES OR SUBSTRUCTURES SHALL NOT BE INSTALLED IN PARALLEL DIRECTLY ABOVE ELECTRIC CONDUITS.
5. CONTRACTOR SHALL PERFORM ALL EXCAVATIONS NECESSARY TO INSTALL ELECTRIC SUBSTRUCTURES. THE ENTIRE ELECTRIC CONDUITS SHALL BE LAID IN PARALLEL TO FINAL FINISHED GRADE. BACKFILL SHALL BE BUILT AND COMPACTED IN ACCORDANCE WITH THE TRENCH REPLACEMENT DETAIL. ALL BACKFILL, SOIL COMPACTION AND FINAL RESURFACING SHALL BE THE RESPONSIBILITY OF CONTRACTOR.
6. CONDUITS ENTERING PULL BOXES FROM THE BOTTOM SHALL EXTEND NO MORE THAN 4" ABOVE THE BOTTOM OF THE PULL BOX AND GRAVEL BASE. CONTRACTOR SHALL INSTALL 1800 LBS POLYESTER MULETAPE WITH PRINTED SEQUENTIAL FOOTAGE PULL LINE IN ALL CONDUITS.
7. ALL PRECAST SUBSTRUCTURES SPECIFIED SHALL BE INSTALLED AS PER APPROVED PLAN AND IN ACCORDANCE WITH THE MANUFACTURER'S INSTRUCTIONS. CONTRACTOR SHALL PROVIDE CRUSHED ROCK BASE UNDER ALL SUBSTRUCTURES. NECESSARY GRADE RINGS OR NECKINGS SHALL BE PROVIDED TO BRING COVERS UP TO FINAL FINISHED GRADE.
8. CONTRACTOR SHALL PROVIDE SEALED PULL BOX OR PAD COVERS WITH THE PROPER COVER FINISH, MARKINGS, BOLTS, HINGED OPENING AND LIFTING HANDLES AND GALVANIZED STEEL OR CONCRETE COVERS. COVERS EXPOSED TO VEHICULAR TRAFFIC SHALL HAVE TRAFFIC COVERS RATED FOR H-20 LOADING.
9. PROTECTIVE BARRIERS SHALL BE INSTALLED AROUND TRANSFORMER PADS AND OTHER DISTRIBUTION STRUCTURES AS REQUIRED ON THE APPROVED PLAN OR WHERE ELECTRIC EQUIPMENT IS EXPOSED TO VEHICULAR TRAFFIC. 4" STEEL PIPE BARRIERS FILLED WITH CONCRETE MOUNTED AT A MINIMUM OF 36" ABOVE FINISHED SHALL BE INSTALLED.

REVISION

---



---



---



---



---



---



---



---



---



---

13620 HWY 99  
 CHICO, CA 95973  
 PHONE#: (530) 345-6980  
 FAX#: (530) 892-2360  
 info@solarenergyforlife.com



BUTTE COUNTY ASSOCIATION OF GOVERNMENTS  
 326 HUSS LANE  
 CHICO, CA 95920  
 APN# 039-060-142  
 CITY OF CHICO

SCALE: N.T.S.  
 DATE MODIFIED: November 20, 2017  
 DATE CREATED: December 9, 2015  
 DESIGNER: E. TRITTEN  
 CONSULTANT: C. ALMAGUER

APN# 039-060-142  
 326 HUSS LANE  
 CHICO, CA 95928  
 ZONE: ML (LIGHT MANUFACTURING)  
 SETBACKS:  
 FRONT=0'  
 CORRIDOR SIDE=0'  
 SIDE=0'  
 REAR=0'

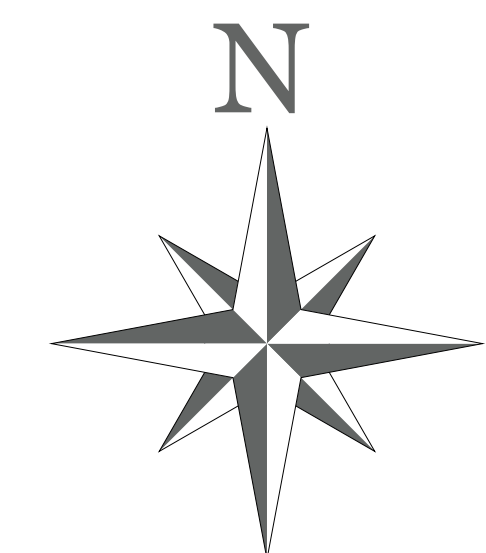
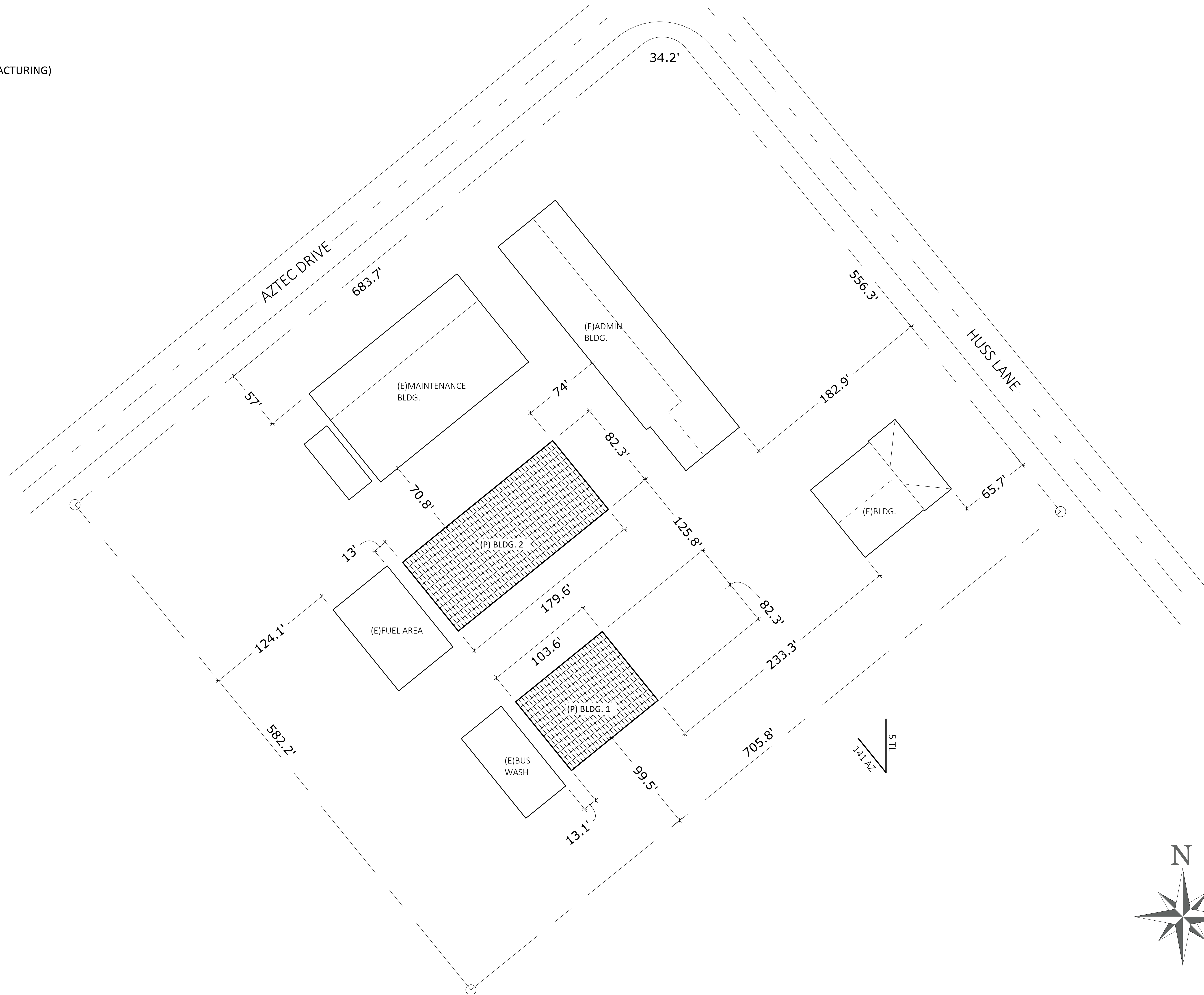

13620 HWY 99  
 CHICO, CA 95973  
 PHONE#: (530) 345-6980  
 FAX#: (530) 892-2360  
 info@solarenergyforlife.com



BUTTE COUNTY ASSOCIATION OF GOVERNMENTS  
 326 HUSS LANE  
 CHICO, CA 95920  
 APN# 039-060-142  
 CITY OF CHICO

SCALE: 1"=40'  
 DATE MODIFIED: November 20, 2017  
 DATE CREATED: December 9, 2015  
 DESIGNER: E. TRITTEN  
 CONSULTANT: C. ALMAGUER

PV-2.0  
 PARCEL  
 SETBACKS



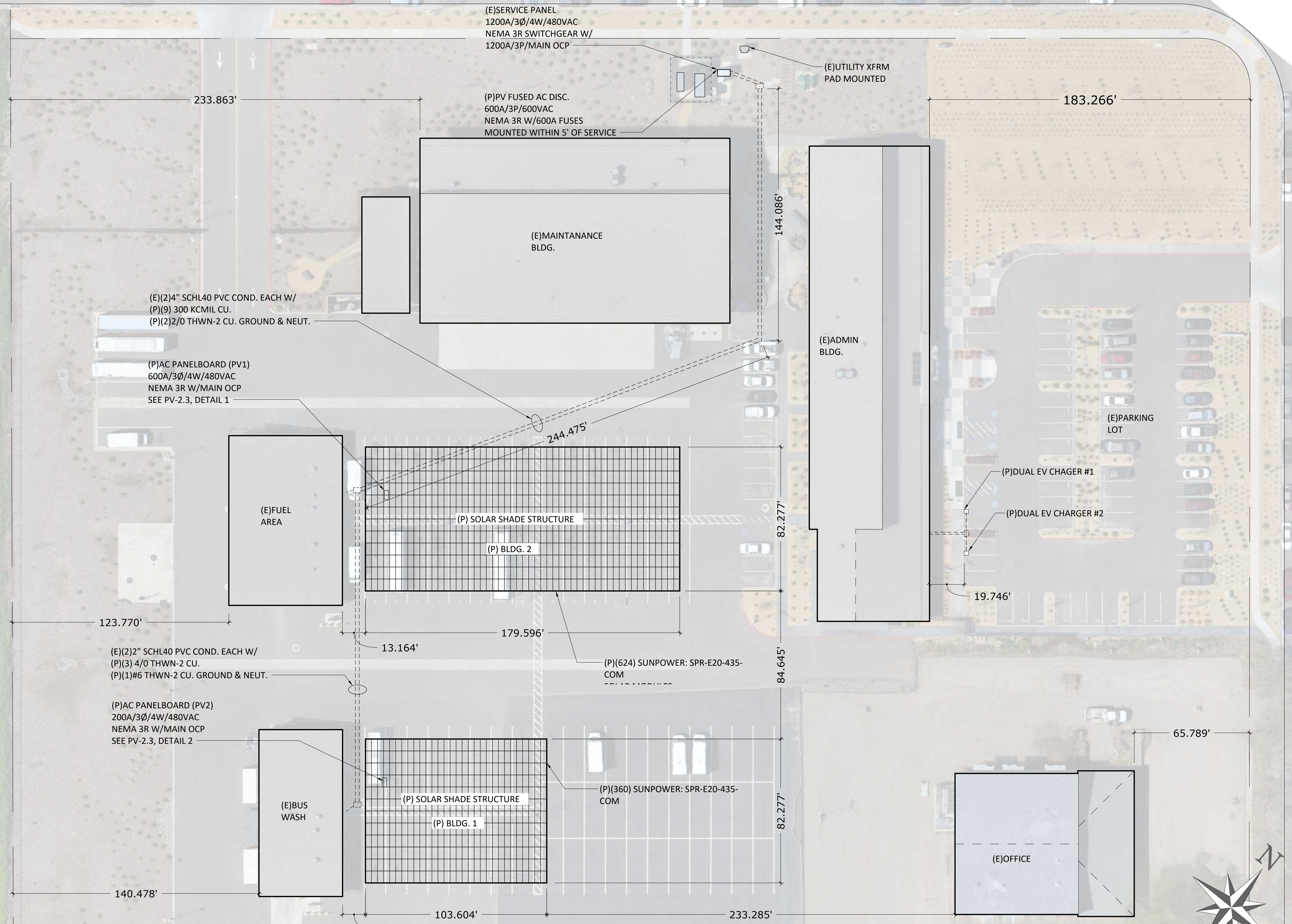

(E)SERVICE PANEL  
1200A/3Ø/4W/480VAC  
NEMA 3R SWITCHGEAR W/  
1200A/3P/MAIN OCP

(E)UTILITY XFRM  
PAD MOUNTED

(P)PV FUSED AC DISC.  
600A/3P/600VAC  
NEMA 3R W/600A FUSES  
MOUNTED WITHIN 5' OF SERVICE

(E)MAINTANANCE  
BLDG.

183.266'

(E)(2)4" SCHL40 PVC COND. EACH W/  
(P)(9) 300 KCMIL CU.  
(P)(2)2/0 THWN-2 CU. GROUND & NEUT.

(P)AC PANELBOARD (PV1)  
600A/3Ø/4W/480VAC  
NEMA 3R W/MAIN OCP  
SEE PV-2.3, DETAIL 1

(E)ADMIN  
BLDG.

(E)PARKING  
LOT

(P)DUAL EV CHAGER #1

(P)DUAL EV CHARGER #2

244.475'

(E)FUEL  
AREA

(P) SOLAR SHADE STRUCTURE

(P) BLDG. 2

82.277'

123.770'

179.596'

(E)(2)2" SCHL40 PVC COND. EACH W/  
(P)(3) 4/0 THWN-2 CU.  
(P)(1)#6 THWN-2 CU. GROUND & NEUT.

13.164'

(P)(624) SUNPOWER: SPR-E20-435-  
COM

84.645'

19.746'

(P)AC PANELBOARD (PV2)  
200A/3Ø/4W/480VAC  
NEMA 3R W/MAIN OCP  
SEE PV-2.3, DETAIL 2

(E)BUS  
WASH

(P) SOLAR SHADE STRUCTURE

(P) BLDG. 1

(P)(360) SUNPOWER: SPR-E20-435-  
COM

82.277'

65.789'

140.478'

103.604'

233.285'

13.056'

(E)OFFICE



13620 HWY 99  
CHICO, CA 95973  
PHONE#: (530) 345-6980  
FAX#: (530) 892-2360  
info@solarenergyforlife.com

**AES**  
Alternative Energy Systems Inc.

BUTTE COUNTY ASSOCIATION OF GOVERNMENTS  
326 HUSS LANE  
CHICO, CA 95920  
APN# 039-060-142  
CITY OF CHICO

SCALE: 1"=25'  
DATE MODIFIED: November 20, 2017  
DATE CREATED: December 9, 2015  
DESIGNER: E. TRITTEN  
CONSULTANT: C. ALMAGUER

**PV-2.1**  
SITE PLAN

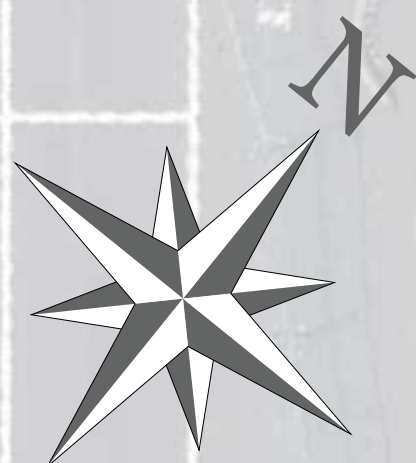
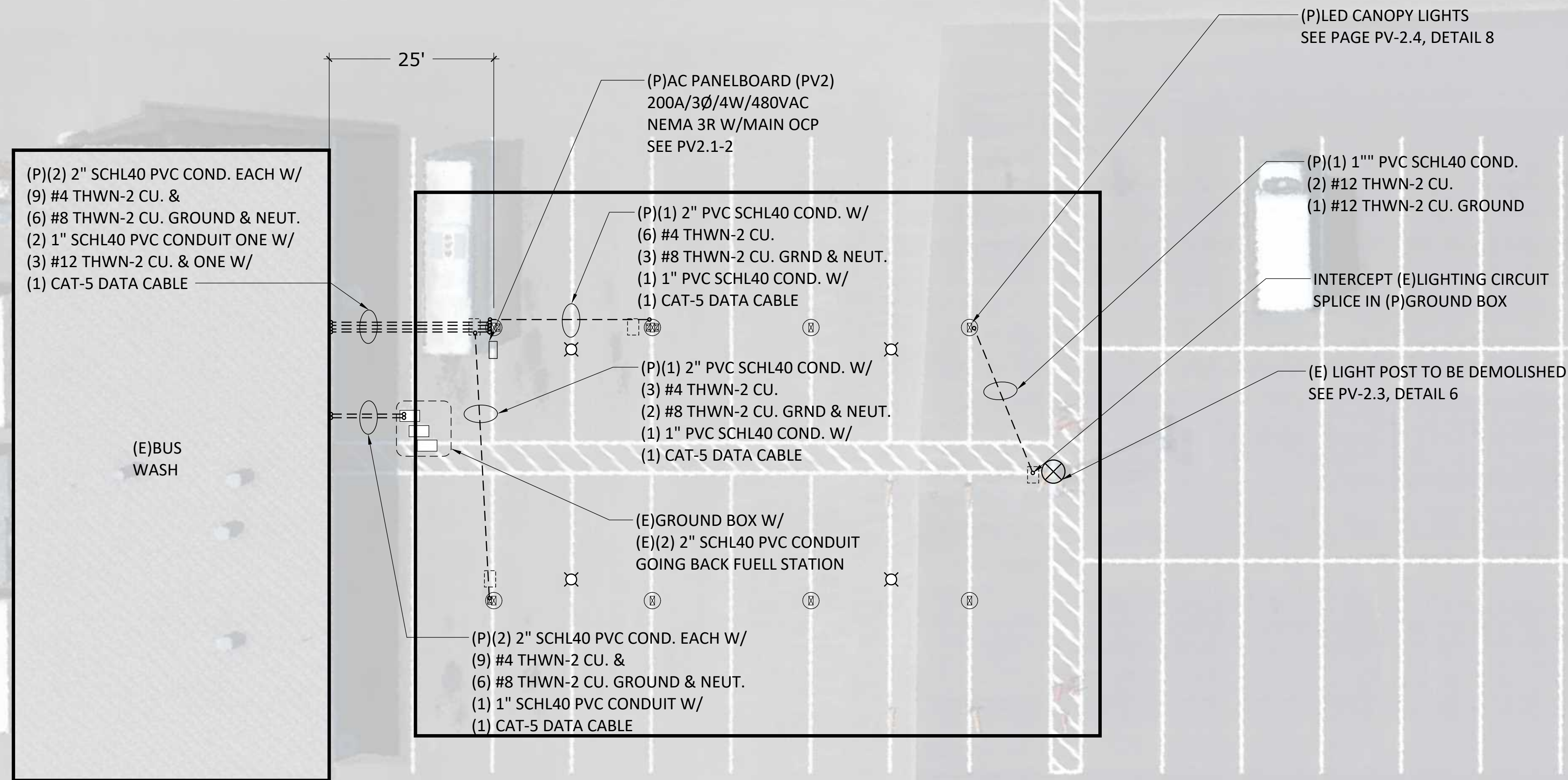
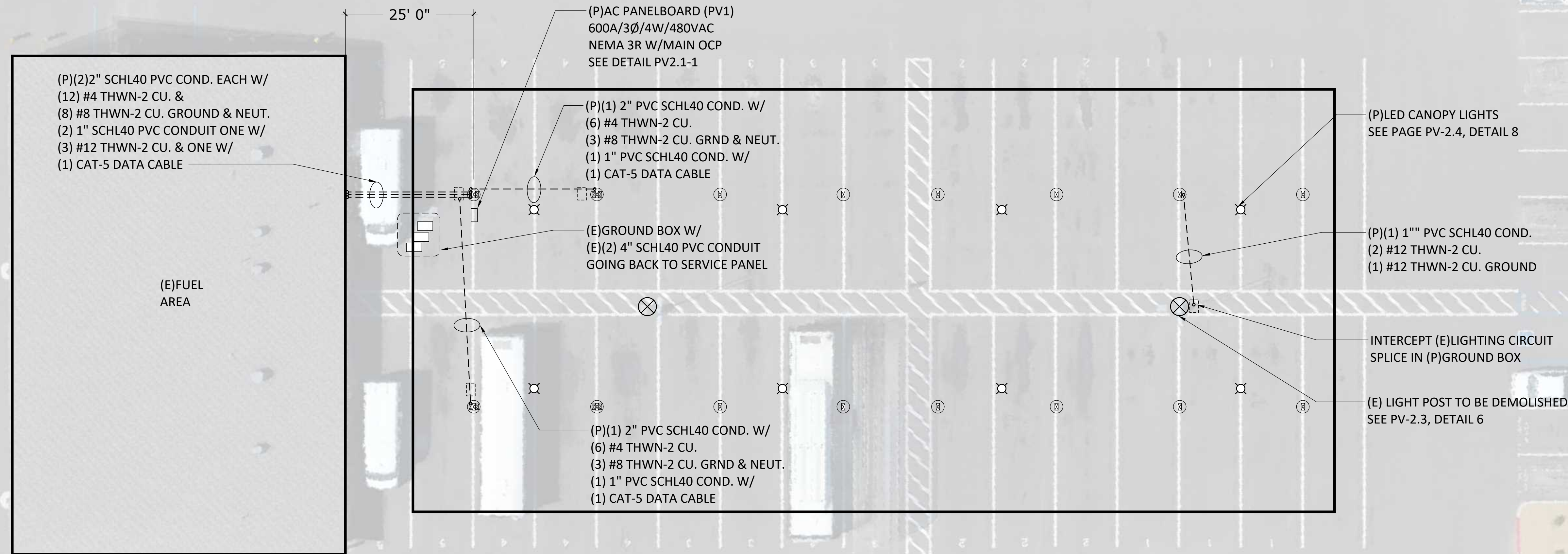

NO.	REVISION

13620 HWY 99  
CHICO, CA 95973  
PHONE#: (530) 345-6980  
FAX#: (530) 892-2360  
info@solarenergyforlife.com



BUTTE COUNTY ASSOCIATION OF GOVERNMENTS  
326 HUSS LANE  
CHICO, CA 95920  
APN# 039-060-142  
CITY OF CHICO

SCALE N.T.S.  
DATE MODIFIED November 20, 2017  
DATE CREATED December 9, 2015  
DESIGNER: E. TRITTEN  
CONSULTANT: C. ALMAGUER

**PV-2.2**  
UNDERGROUND  
PLAN

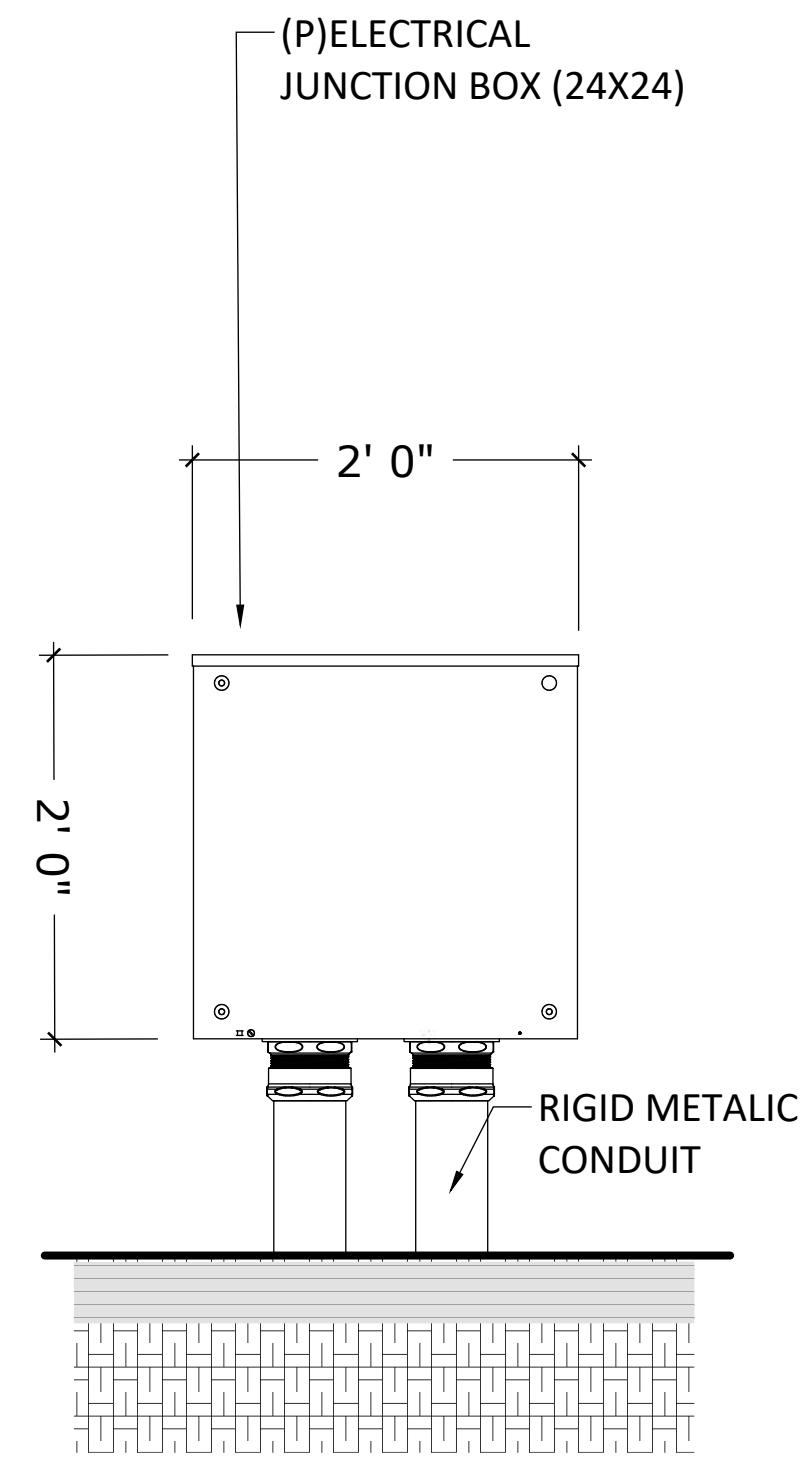

JUNCTION BOX **1.1**

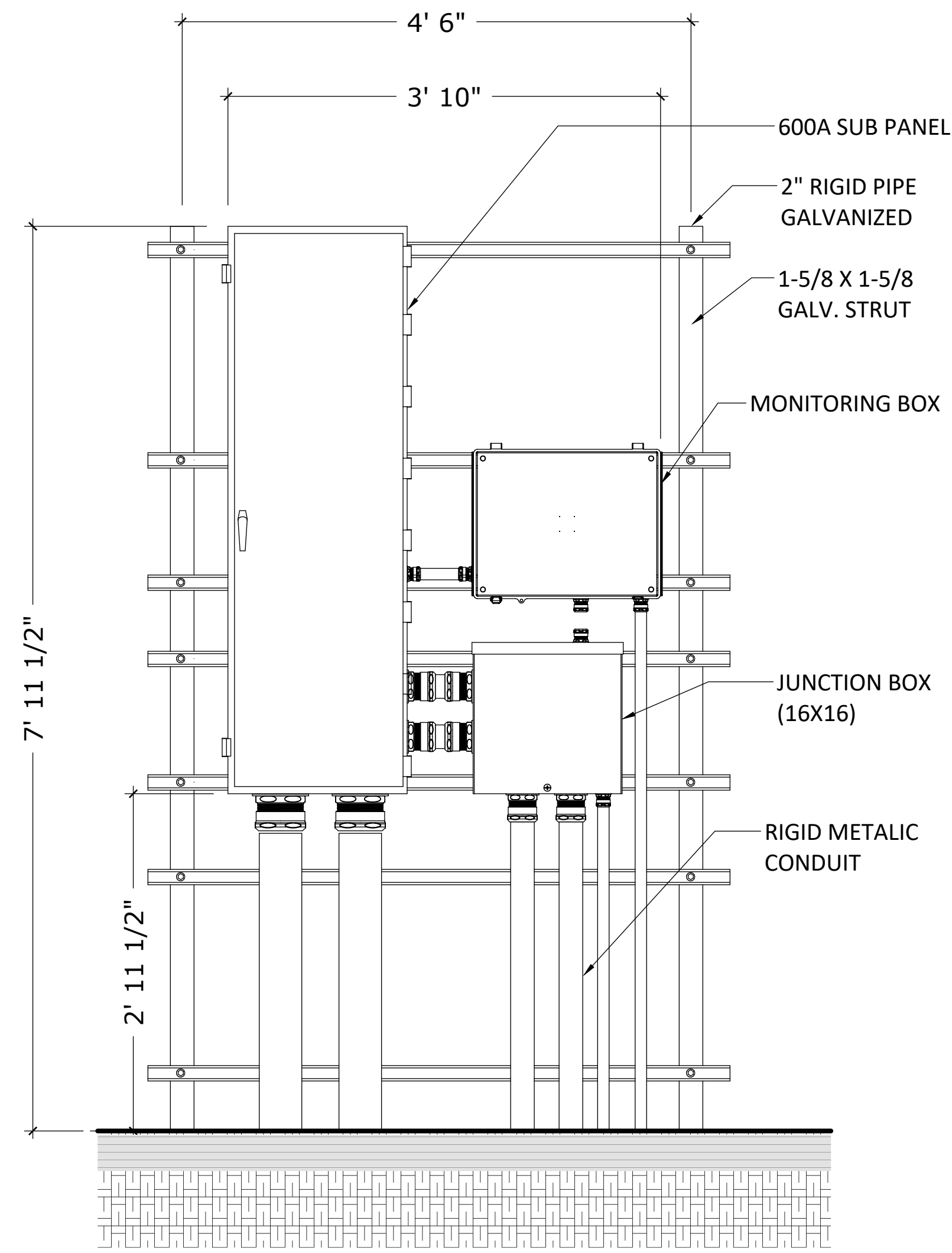

SUB PANEL PV1 DETAIL **1**

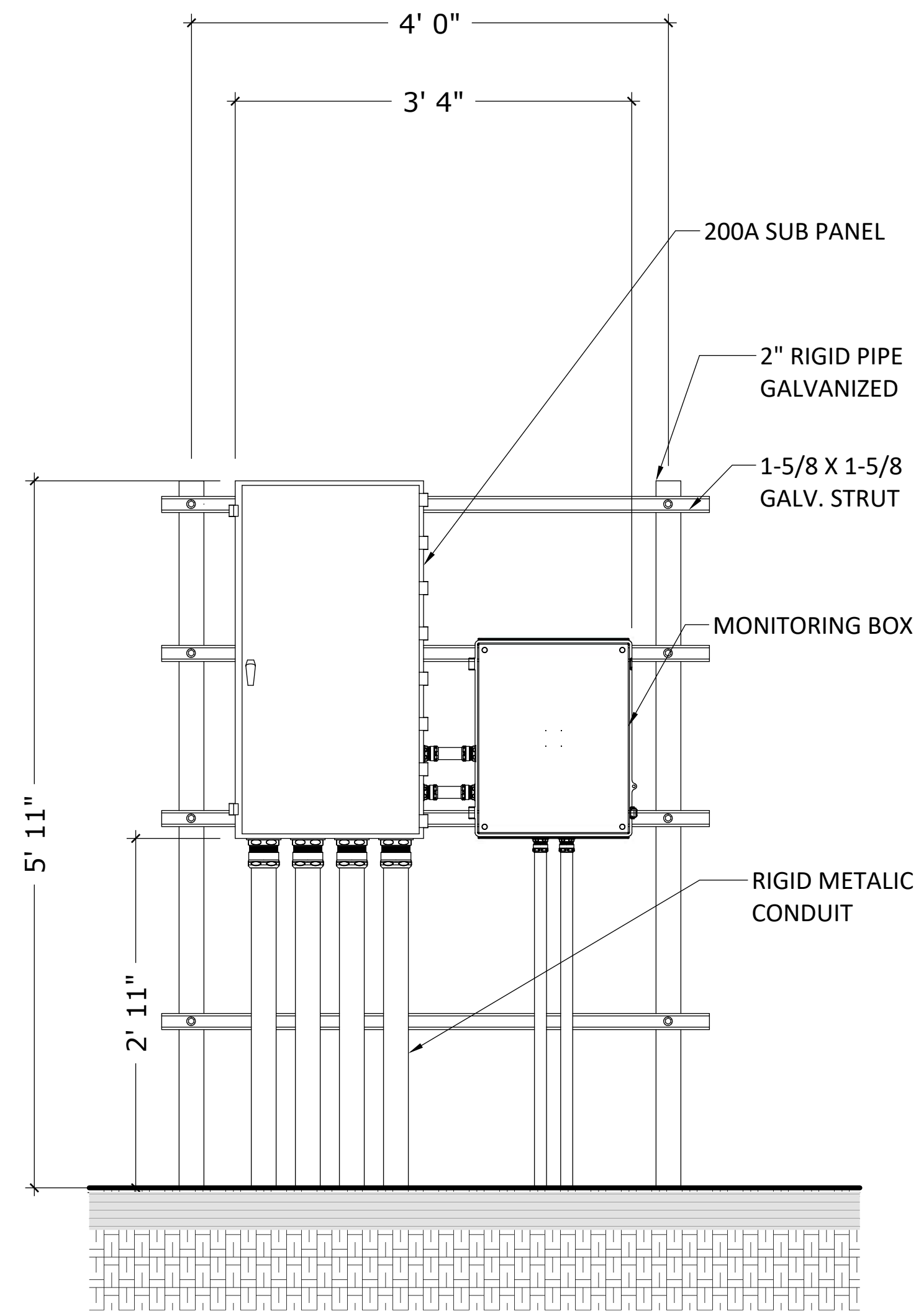

SUB PANEL PV2 DETAIL **2**

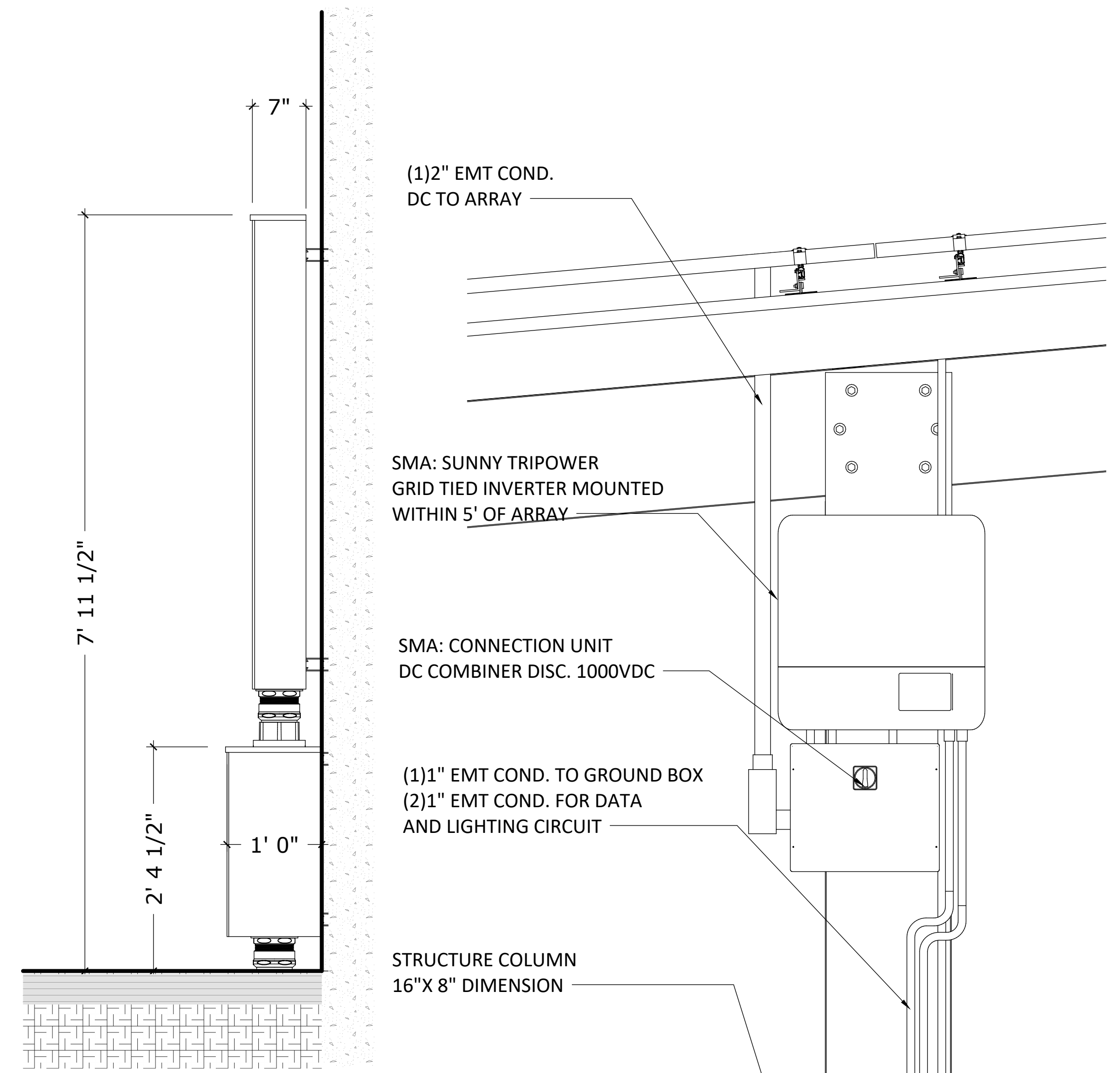

SUB PANEL PV2 SIDE DETAIL **3**

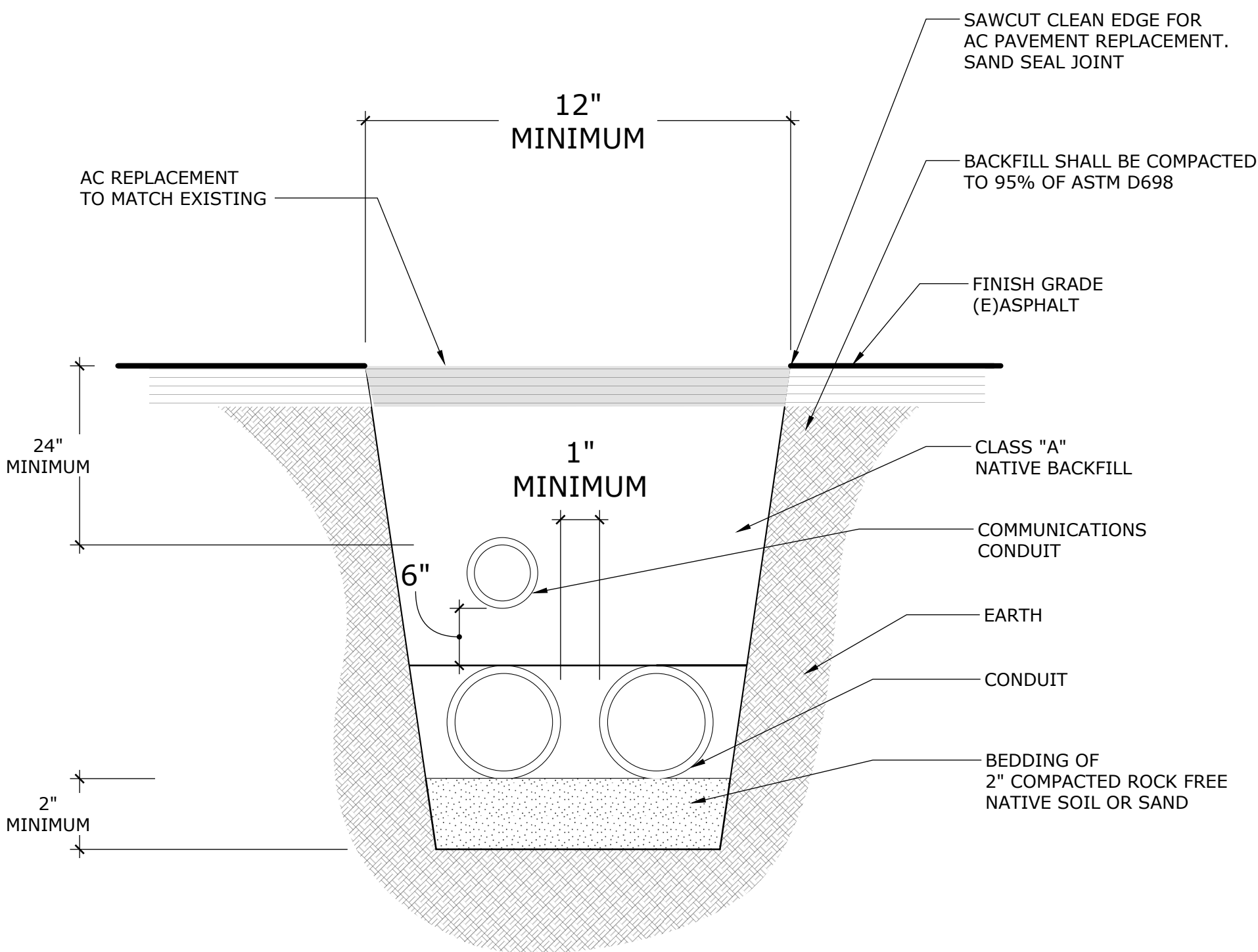

TRENCH FILL DETAIL **4**

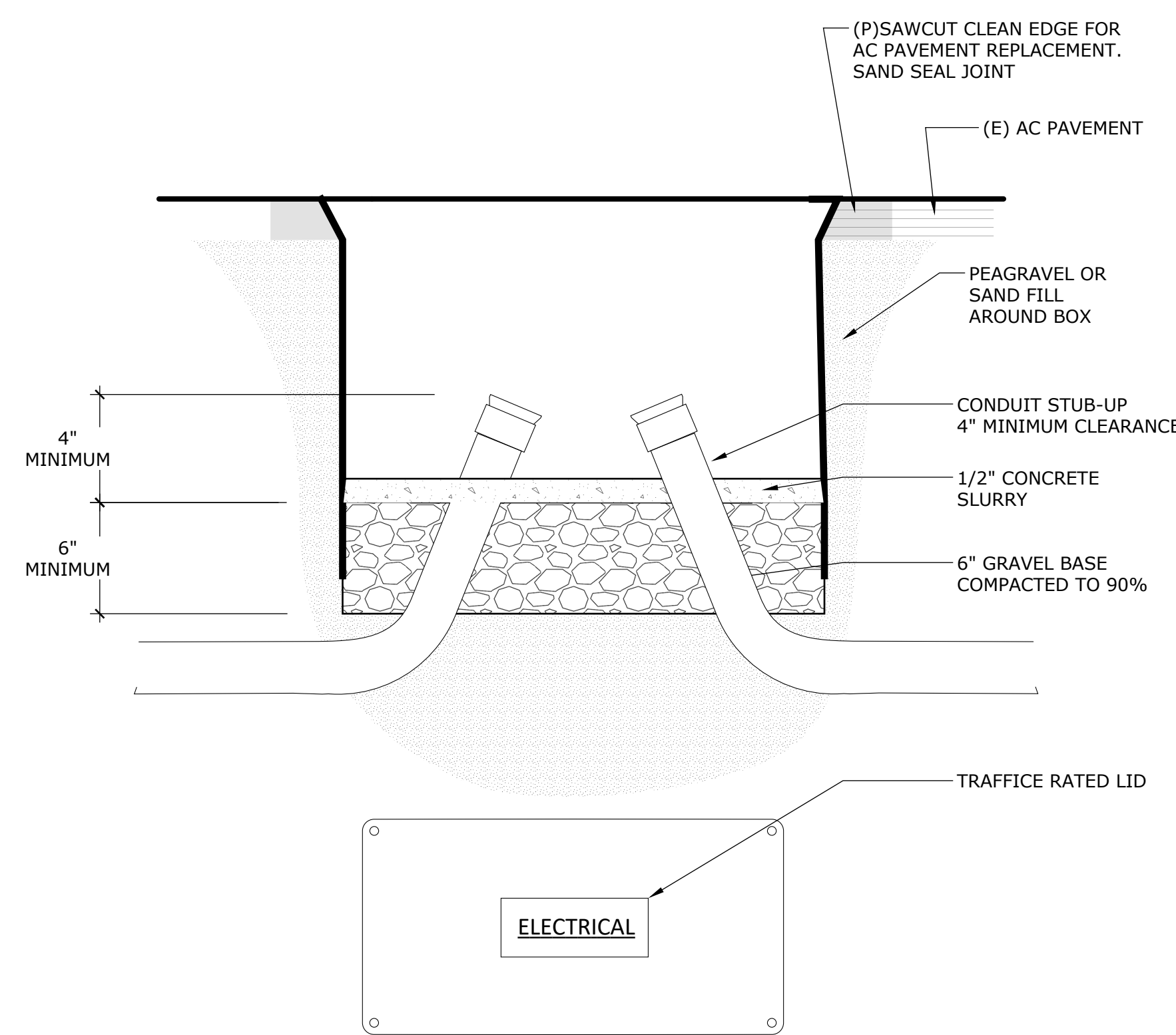

GROUND BOX DETAIL **5**

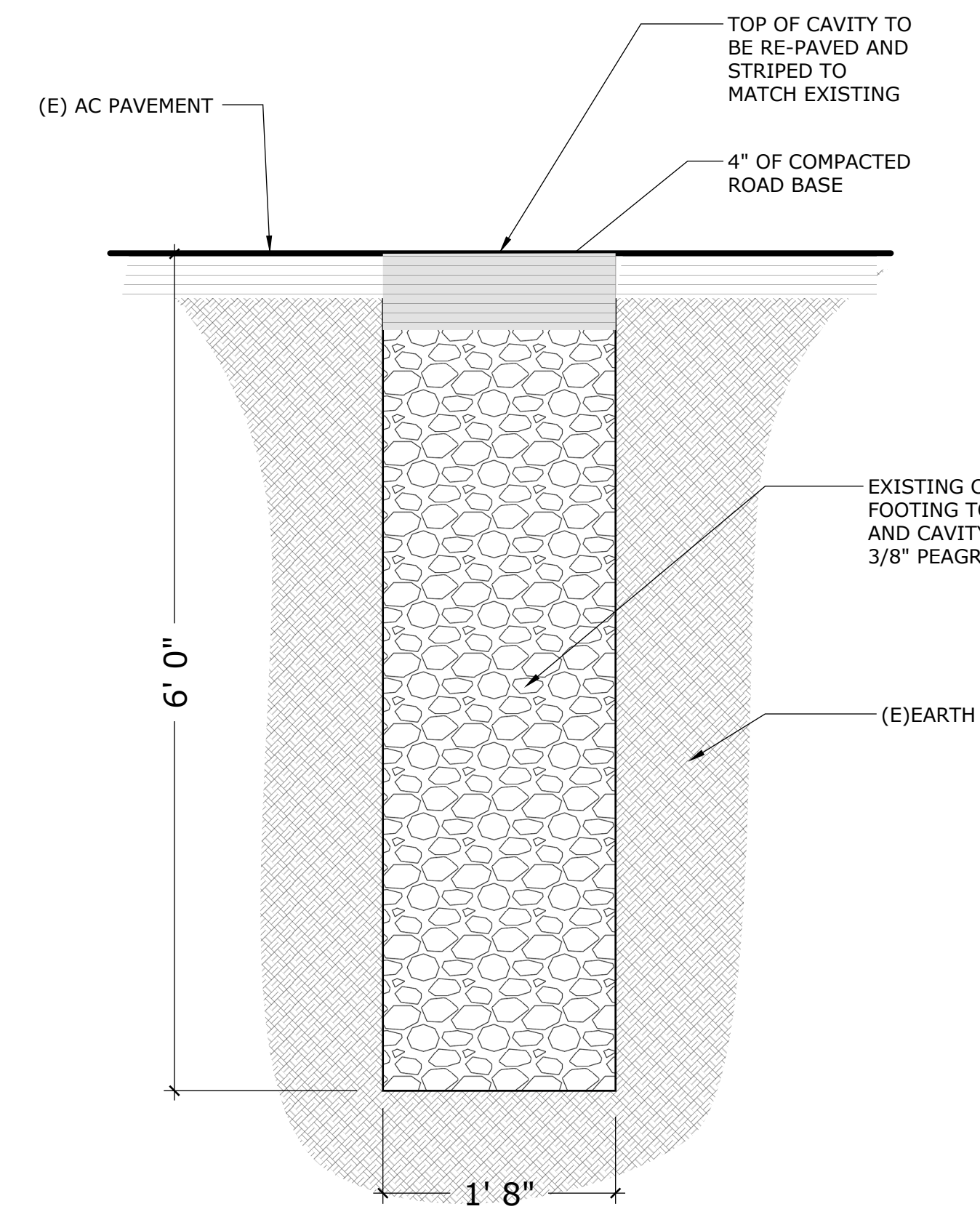

EXISTING LAMP POST DEMOLITION **6**

INVERTER MOUNTING DETAIL **7**

13620 HWY 99  
CHICO, CA 95973  
PHONE#: (530) 345-6980  
FAX#: (530) 892-2360  
info@solarenergyforlife.com



BUTTE COUNTY ASSOCIATION OF GOVERNMENTS  
326 HUSS LANE  
CHICO, CA 95920  
APN# 039-060-142  
CITY OF CHICO

SCALE: N.T.S.  
DATE MODIFIED: November 20, 2017  
DATE CREATED: December 9, 2015  
DESIGNER: E. TRITTEN  
CONSULTANT: C. ALMAGUER

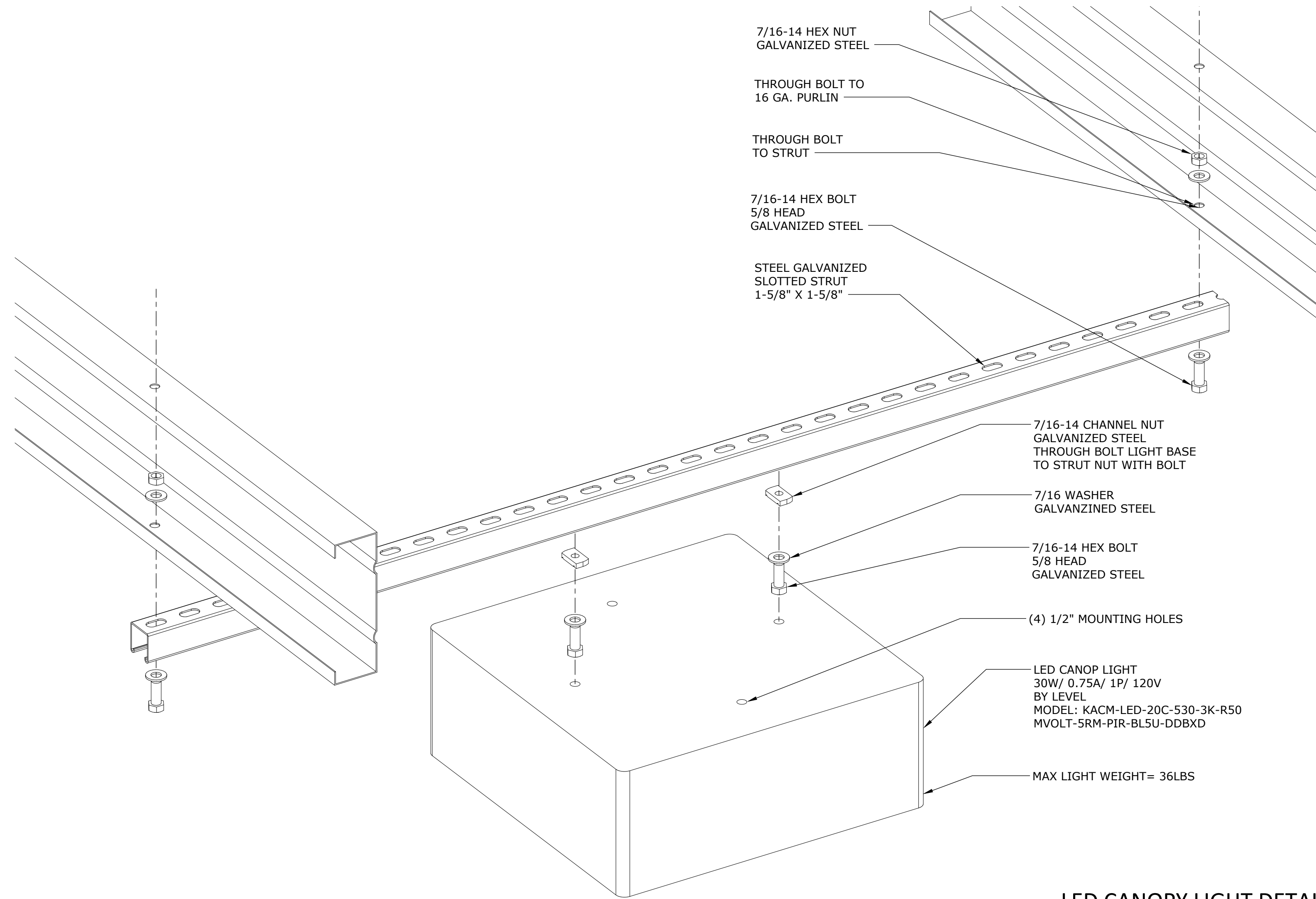

LED CANOPY LIGHT DETAIL 8

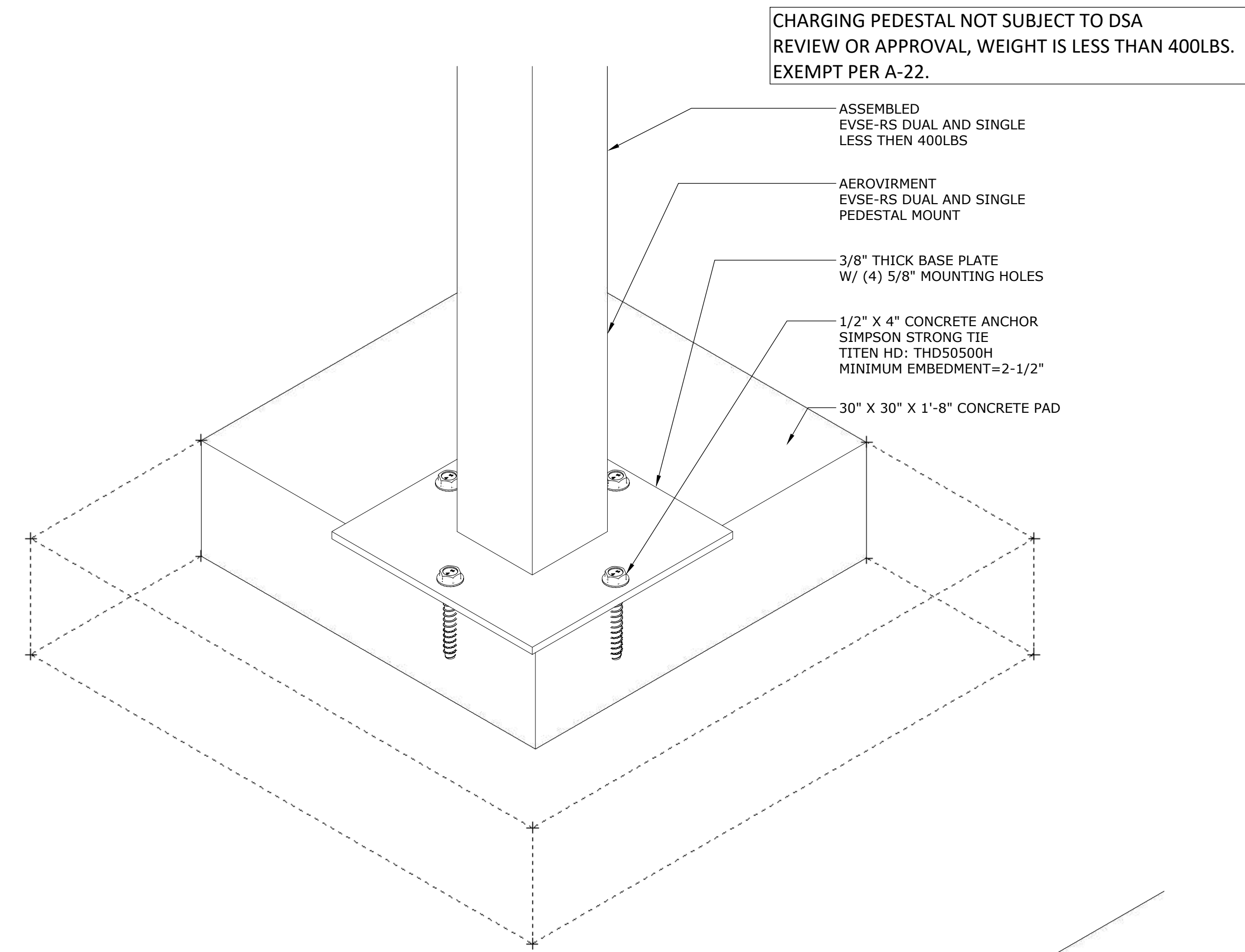

EV CHARGER PEDESTAL DETAIL 10

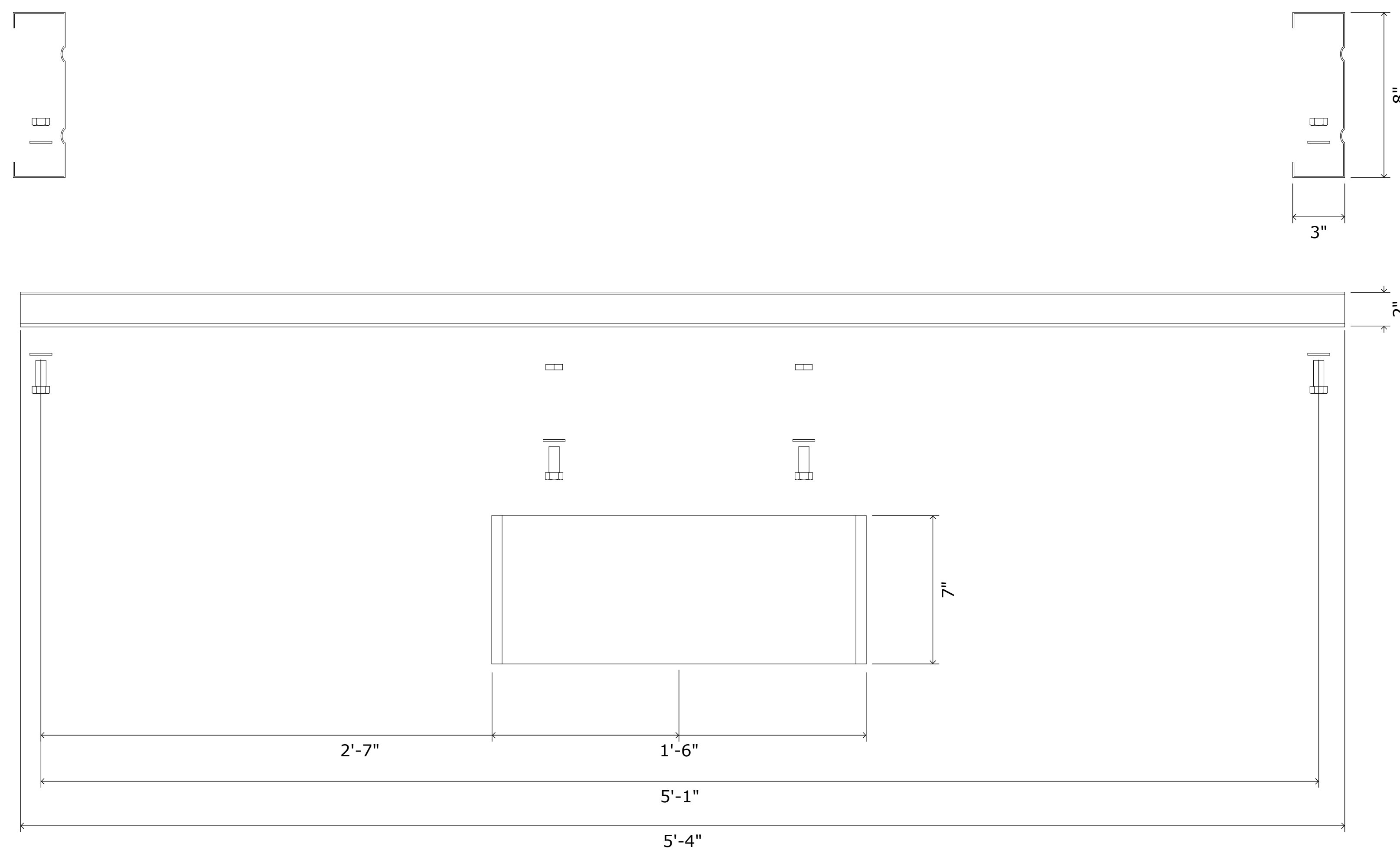

LED CANOPY LIGHT SIDE VIEW 9

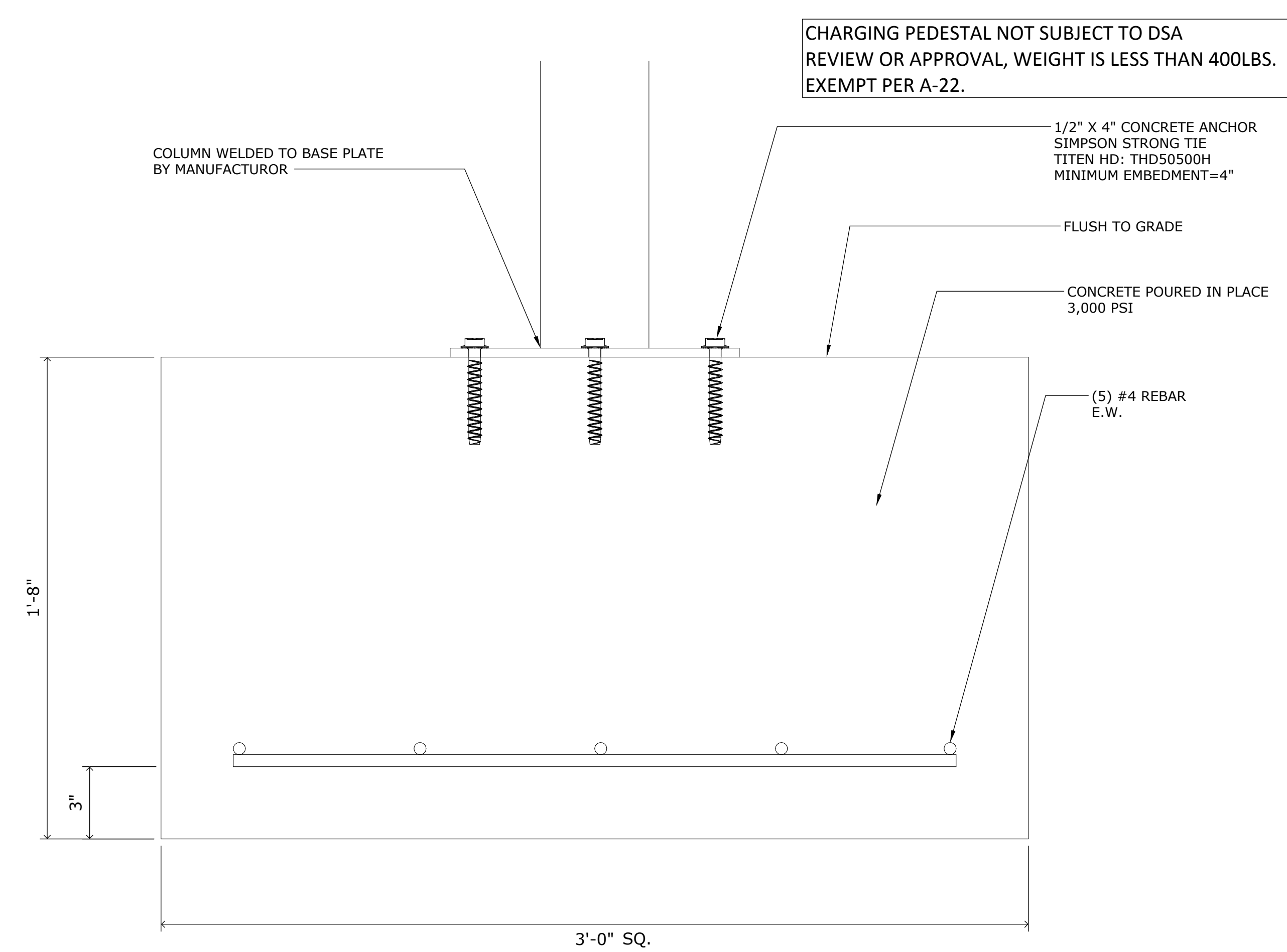

EV CHARGING PEDESTAL SIDE VIEW 11

13620 HWY 99  
CHICO, CA 95973  
PHONE#: (530) 345-6980  
FAX#: (530) 892-2360  
info@solarenergyforlife.com



BUTTE COUNTY ASSOCIATION OF GOVERNMENTS  
326 HUSS LANE  
CHICO, CA 95920  
APN# 039-060-142  
CITY OF CHICO

SCALE: N.T.S.  
DATE MODIFIED: November 20, 2017  
DATE CREATED: December 9, 2015  
DESIGNER: E. TRITTEN  
CONSULTANT: C. ALMAGUER

PV-2.4  
LIGHTING &  
EV DETAILS

# BUILDING 2

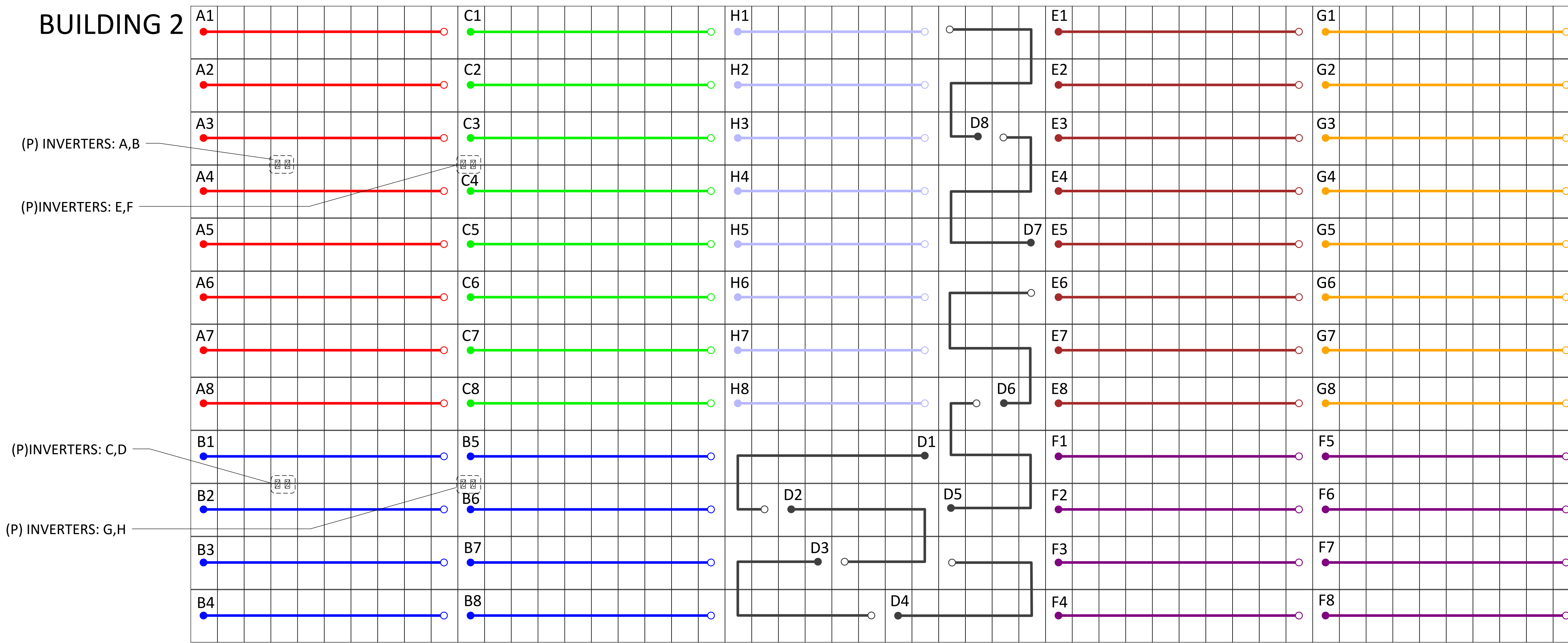

BUILDING 2:  
 (7) SMA: STP30000TL-US-10, EACH WITH (8) STRINGS OF 10  
 (1) SMA: STP24000TL-US-10, EACH WITH (8) STRINGS OF 8

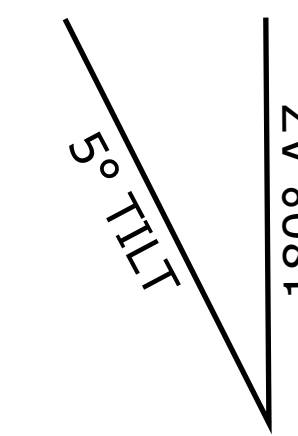

# BUILDING 1

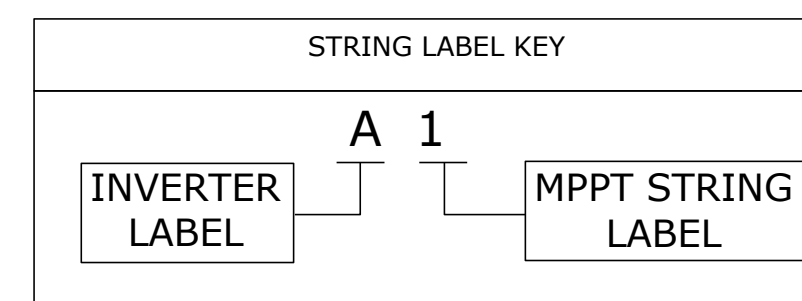
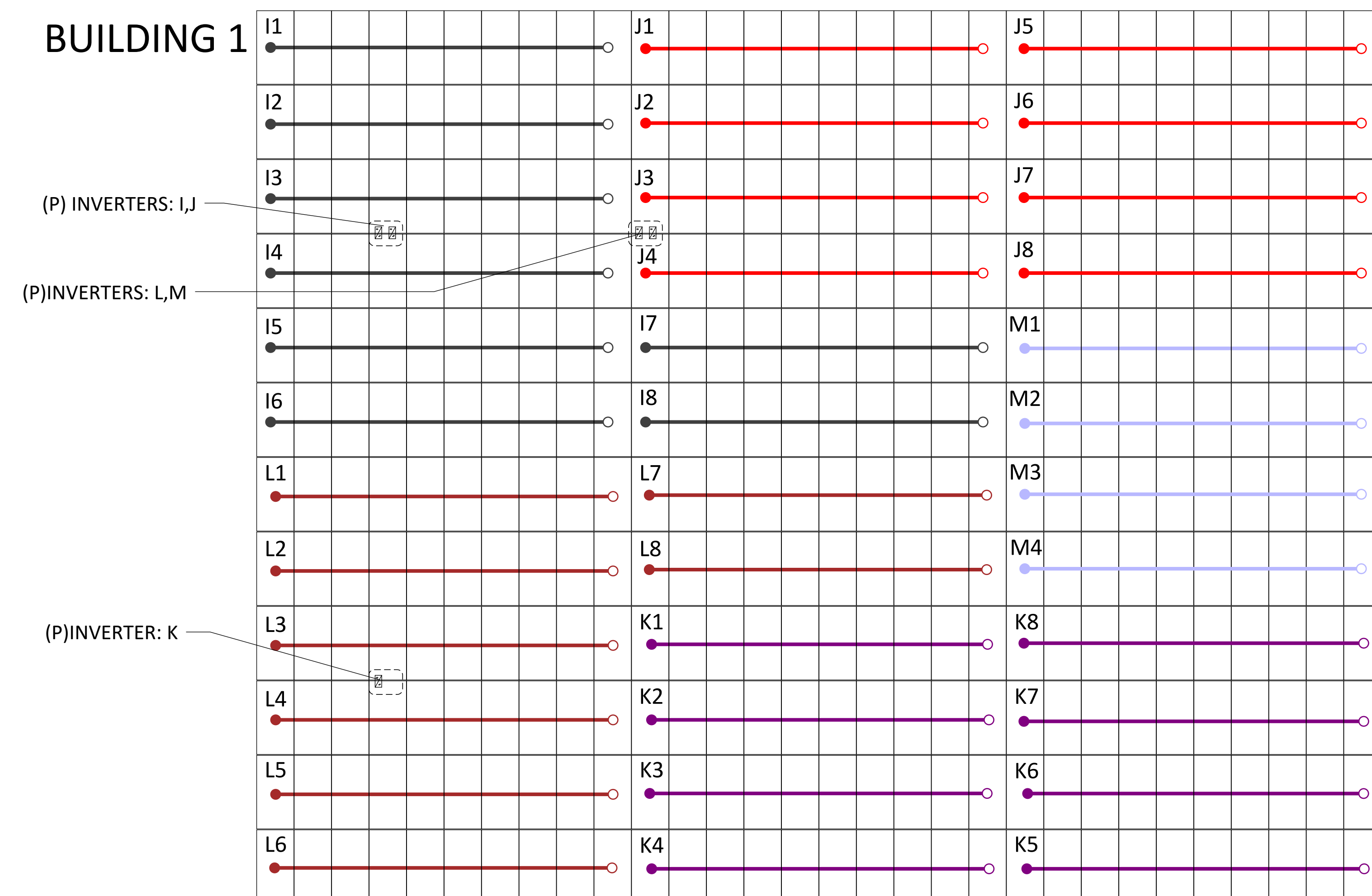

### NOTES

1. POSITIVE HOME RUNS TO BE DESIGNATED WITH RED 2KV PV WIRE.
2. NEGATIVE HOME RUNS TO BE DESIGNATED WITH BLACK 2KV PV WIRE
3. ALL CONNECTORS TO USE MC-4 WEATHER PROOF LOCKING CONNECTORS
4. ALL CONDUCTORS TO BE SECURED TO RAIL AND OR MODULES AS TO NOT TOUCH ROOF SURFACE.

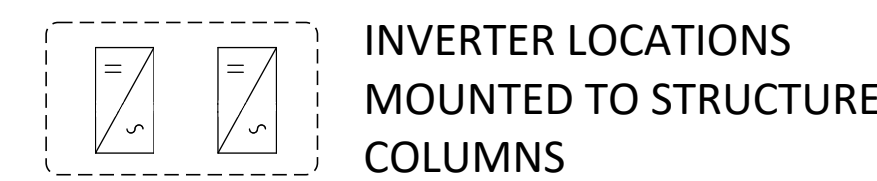

BUILDING 1:  
 (4) SMA: STP30000TL-US-10, EACH WITH (8) STRINGS OF 10  
 (1) SMA: STP15000TL-US-10, EACH WITH (2) STRINGS OF 10 & (2) STRINGS OF 7

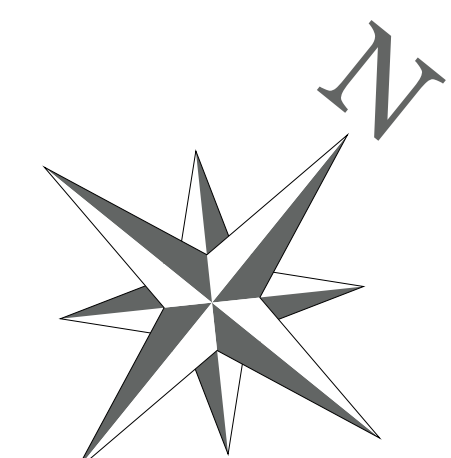

13620 HWY 99  
 CHICO, CA 95973  
 PHONE#: (530) 345-6980  
 FAX#: (530) 892-2360  
 info@solarenergyforlife.com



BUTTE COUNTY ASSOCIATION OF GOVERNMENTS  
 326 HUSS LANE  
 CHICO, CA 95920  
 APN# 039-060-142  
 CITY OF CHICO

SCALE: 1/8"=1'  
 DATE MODIFIED: November 20, 2017  
 DATE CREATED: December 9, 2015  
 DESIGNER: E. TRITTEN  
 CONSULTANT: C. ALMAGUER

PV-2.5  
 STRINGING  
 DIAGRAM

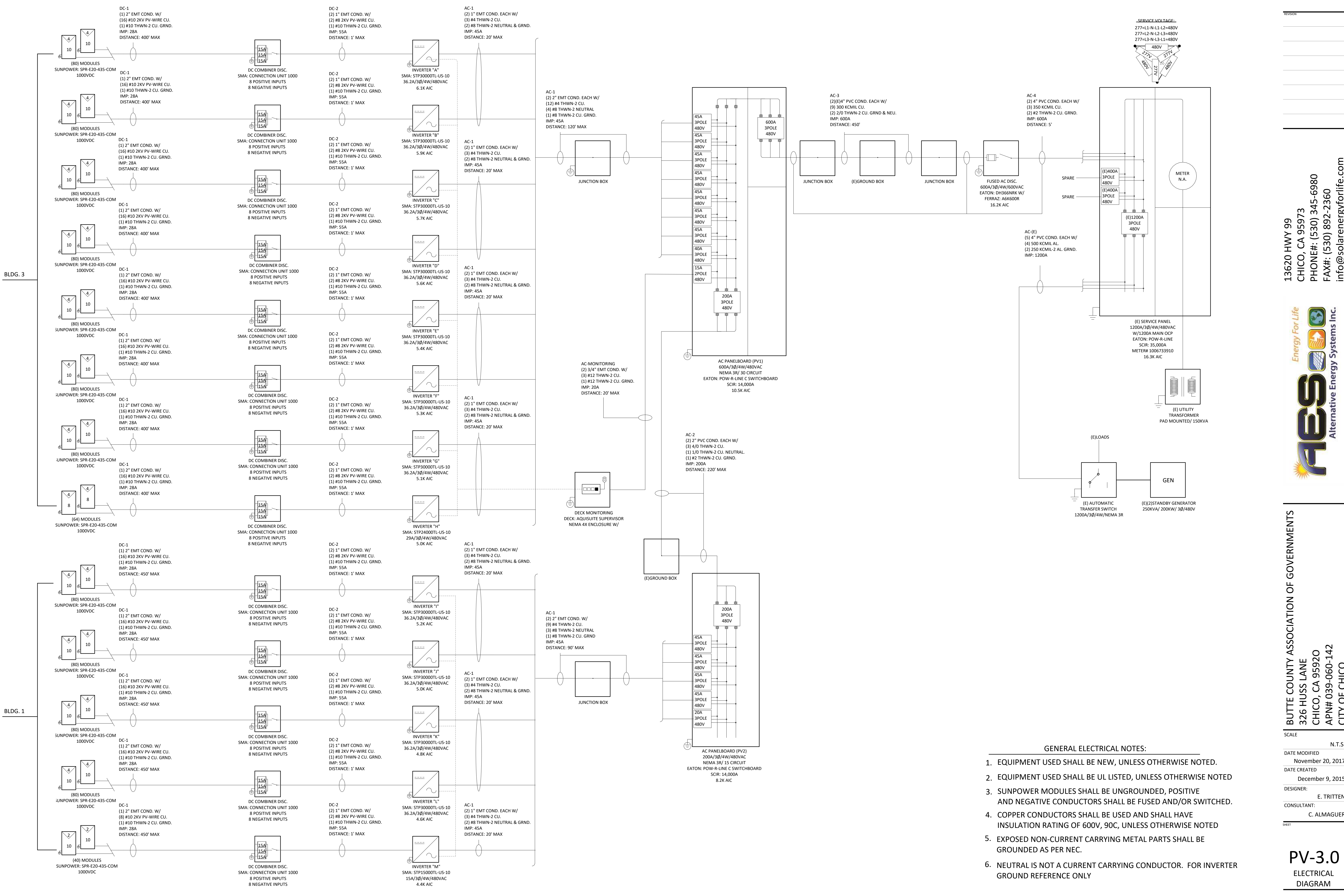

- GENERAL ELECTRICAL NOTES:**
- EQUIPMENT USED SHALL BE NEW, UNLESS OTHERWISE NOTED.
  - EQUIPMENT USED SHALL BE UL LISTED, UNLESS OTHERWISE NOTED
  - SUNPOWER MODULES SHALL BE UNGROUNDED, POSITIVE AND NEGATIVE CONDUCTORS SHALL BE FUSED AND/OR SWITCHED.
  - COPPER CONDUCTORS SHALL BE USED AND SHALL HAVE INSULATION RATING OF 600V, 90C, UNLESS OTHERWISE NOTED
  - EXPOSED NON-CURRENT CARRYING METAL PARTS SHALL BE GROUNDED AS PER NEC.
  - NEUTRAL IS NOT A CURRENT CARRYING CONDUCTOR. FOR INVERTER GROUND REFERENCE ONLY

SCALE \_\_\_\_\_

N.T.S.

DATE MODIFIED \_\_\_\_\_

November 20, 2017

DATE CREATED \_\_\_\_\_

December 9, 2015

DESIGNER: \_\_\_\_\_

E. TRITTEN

CONSULTANT: \_\_\_\_\_

C. ALMAGUER

SHEET \_\_\_\_\_

13620 HWY 99  
 CHICO, CA 95973  
 PHONE#: (530) 345-6980  
 FAX#: (530) 892-2360  
 info@solarenergyforlife.com



**BUTTE COUNTY ASSOCIATION OF GOVERNMENTS**  
 326 HUSS LANE  
 CHICO, CA 95920  
 APN# 039-060-142  
 CITY OF CHICO

**PV-3.0**  
 ELECTRICAL  
 DIAGRAM

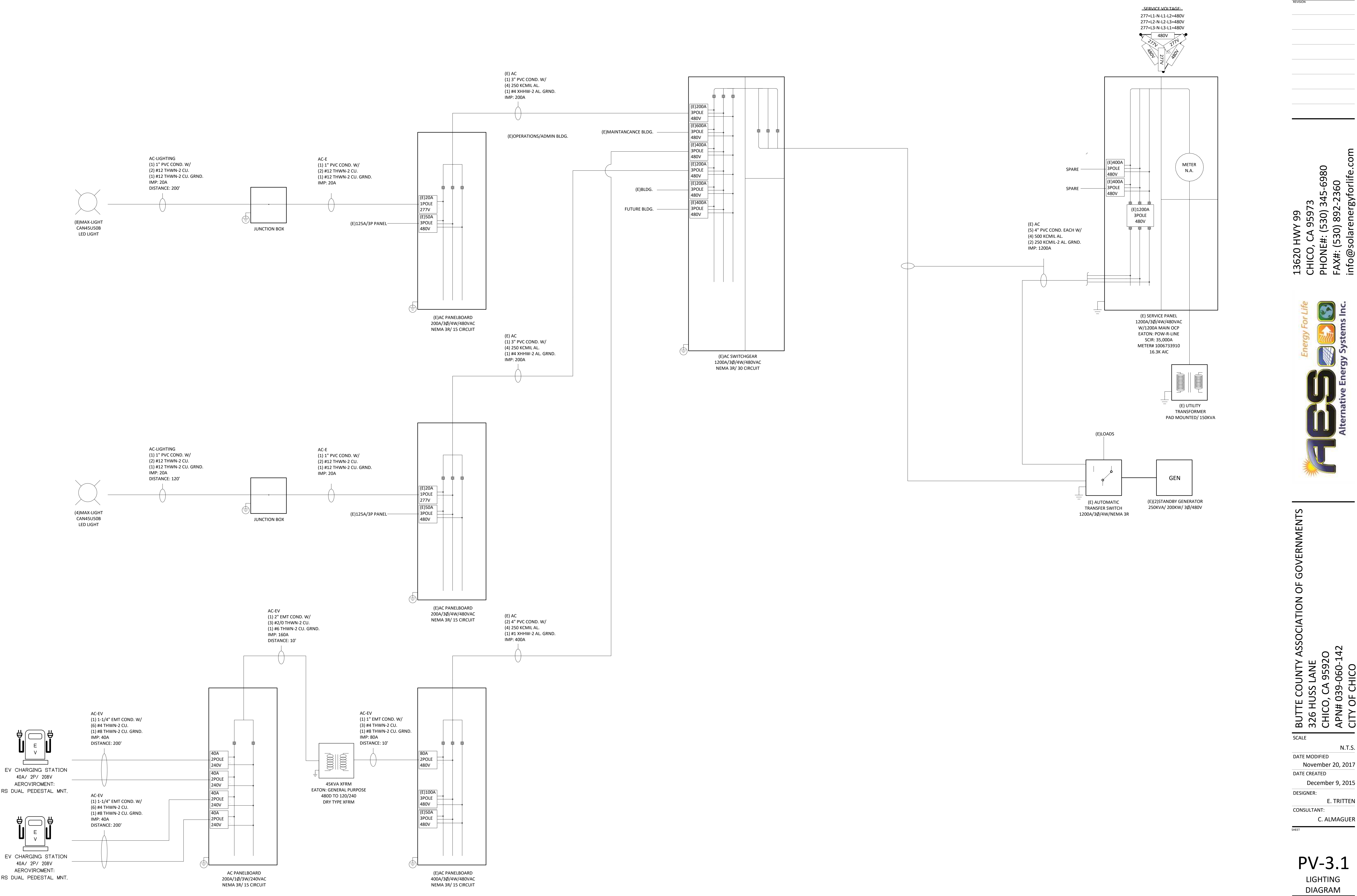

13620 HWY 99  
 CHICO, CA 95973  
 PHONE#: (530) 345-6980  
 FAX#: (530) 892-2360  
 info@solarenergyforlife.com



BUTTE COUNTY ASSOCIATION OF GOVERNMENTS  
 326 HUSS LANE  
 CHICO, CA 95920  
 APN# 039-060-142  
 CITY OF CHICO

SCALE: N.T.S.  
 DATE MODIFIED: November 20, 2017  
 DATE CREATED: December 9, 2015  
 DESIGNER: E. TRITTEN  
 CONSULTANT: C. ALMAGUER



(E) SERVICE PANEL  
 1200A/3Ø/4W/480VAC  
 W/1200A MAIN OCP  
 EATON: POW-R-LINE  
 SCIR: 35,000A  
 METER# 1006733910

NON-FUSED AC DISC.  
 600A/3Ø/4W/600VAC  
 EATON: DH366URK W/

(E)1200A/3P/600VAC  
 MAIN OCP

METER# 1006733910

POINT OF SUPPLY SIDE  
 CONNECTION TO  
 1200A BUSSING  
 THROUGH BOLTED USING  
 CRIMP ON SPADE CONNECTORS



PV SYSTEM AC CONDUCTORS  
 ROUTED THROUGH (E)CUSTOMER  
 SECTION OF SWITCHGEAR



13620 HWY 99  
 CHICO, CA 95973  
 PHONE#: (530) 345-6980  
 FAX#: (530) 892-2360  
 info@solarenergyforlife.com



BUTTE COUNTY ASSOCIATION OF GOVERNMENTS  
 326 HUSS LANE  
 CHICO, CA 95920  
 APN# 039-060-142  
 CITY OF CHICO

SCALE: N.T.S.  
 DATE MODIFIED: November 20, 2017  
 DATE CREATED: December 9, 2015  
 DESIGNER: E. TRITTEN  
 CONSULTANT: C. ALMAGUER



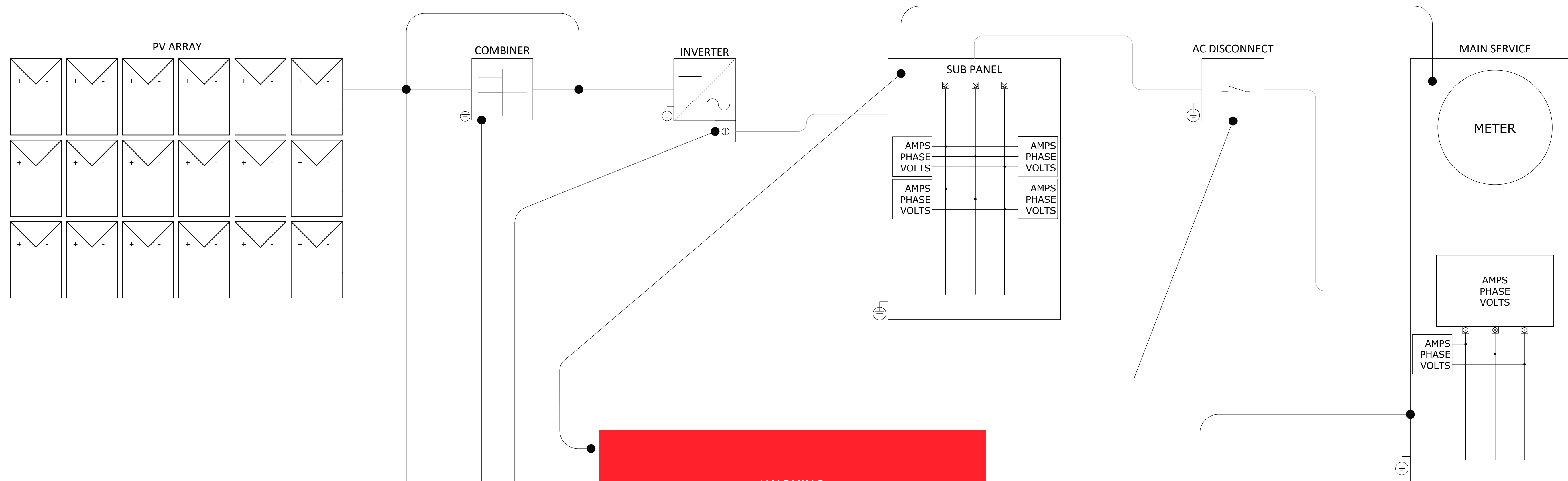

**CAUTION: SOLAR CIRCUIT**

Installed on all DC conduit every 10' and on both sides of any penetration.

**CAUTION!  
SOLAR CIRCUIT  
VOLTAGES UP TO 1000V MAY BE PRESENT  
AUTHORIZED PERSONNEL ONLY!**

Installed on all DC Junction boxes.

**WARNING!  
ELECTRIC SHOCK HAZARD  
THE DC CONDUCTORS OF THIS PHOTOVOLTAIC SYSTEM ARE  
UNGROUNDING AND  
MAY BE ENERGIZED**

Per NEC 690.35(F), Warning shock hazard, at each junction box, combiner box or other device opened during service.

**WARNING  
UTILITY INTERACTIVE POWER  
FLOWING THROUGH THIS PANEL  
KW SOLAR GENERATOR  
AC OPERATING VOLTAGE:  
\_\_\_/\_\_\_VAC/\_\_\_PHASE  
DC DISCONNECT LOCATED ON INVERTER(S)  
LOCATED \_\_\_\_\_**

Per NEC 690.54, Interactive Point of Interconnection installed at all Electrical Distribution Panel covers that provide a path from PV to Utility.

**PHOTOVOLTAIC  
DISCONNECT  
OPERATING CURRENT: \_\_\_A  
SHORT CIRCUIT CURRENT: \_\_\_A  
OPERATING VOLTAGE: \_\_\_VDC  
MAX SYSTEM VOLTAGE: \_\_\_VDC  
WARNING SHOCK HAZARD!  
DO NOT TOUCH TERMINALS. TERMINALS OF BOTH LINE AND  
LOAD SIDE MAY BE ENERGIZED IN OPEN POSITION.**

Per NEC 690.14, Solar Disconnect on the front of all PV DC Disconnects. Filled out in accordance with NEC 690.55

**WARNING  
DUAL POWER SUPPLY  
PHOTOVOLTAIC SYSTEM**

Per NEC 705.10, Point of Connection, Located On Main Service Panel.

**AC PHOTOVOLTAIC  
DISCONNECT  
FOR UTILITY  
OPERATION**

Per NEC 690.14, Disconnection means at the single AC Disconnect or Main Breaker.

**SOLAR BREAKER  
DO NOT RELOCATE**

Solar breaker label @ any breaker passing Bi-Directional Power

REVISION

13620 HWY 99  
CHICO, CA 95973  
PHONE#: (530) 345-6980  
FAX#: (530) 892-2360  
info@solarenergyforlife.com



BUTTE COUNTY ASSOCIATION OF GOVERNMENTS  
326 HUSS LANE  
CHICO, CA 95920  
APN# 039-060-142  
CITY OF CHICO

SCALE: N.T.S.  
DATE MODIFIED: November 20, 2017  
DATE CREATED: December 9, 2015  
DESIGNER: E. TRITTEN  
CONSULTANT: C. ALMAGUER

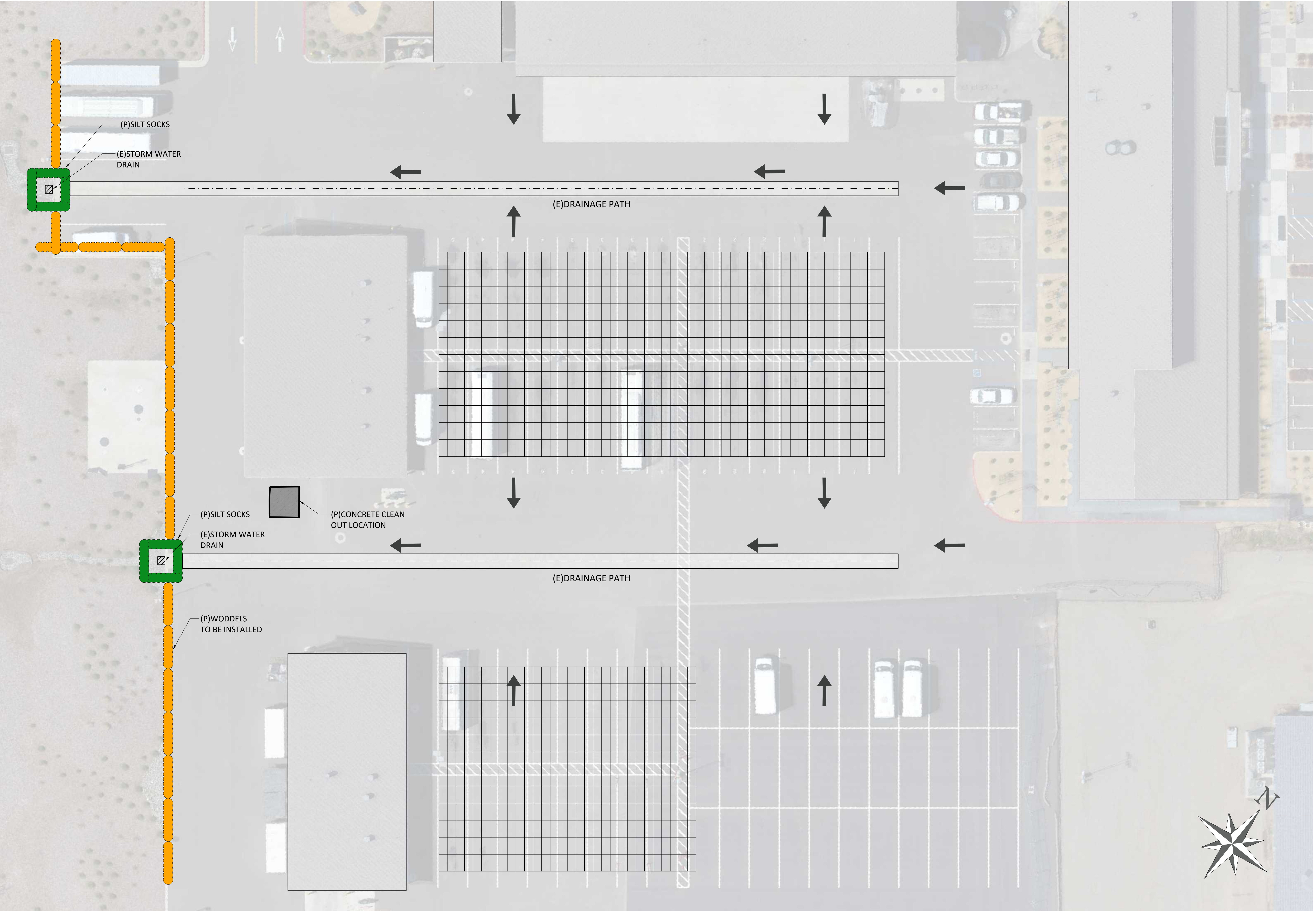

REVISION

13620 HWY 99  
 CHICO, CA 95973  
 PHONE#: (530) 345-6980  
 FAX#: (530) 892-2360  
 info@solarenergyforlife.com



BUTTE COUNTY ASSOCIATION OF GOVERNMENTS  
 326 HUSS LANE  
 CHICO, CA 95920  
 APN# 039-060-142  
 CITY OF CHICO

SCALE 1/16"=1'  
 DATE MODIFIED November 20, 2017  
 DATE CREATED December 9, 2015  
 DESIGNER: E. TRITTEN  
 CONSULTANT: C. ALMAGUER

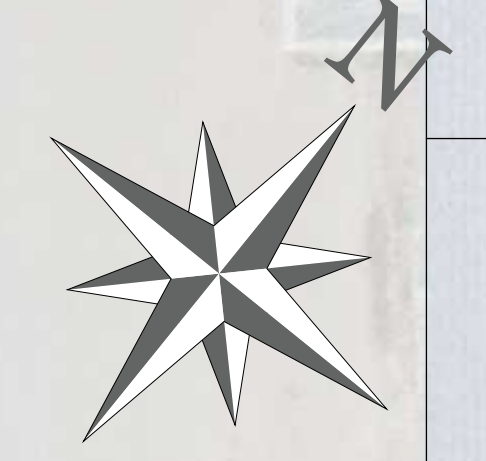

PV-4.0  
 EROSION &  
 SED. CONTROLL



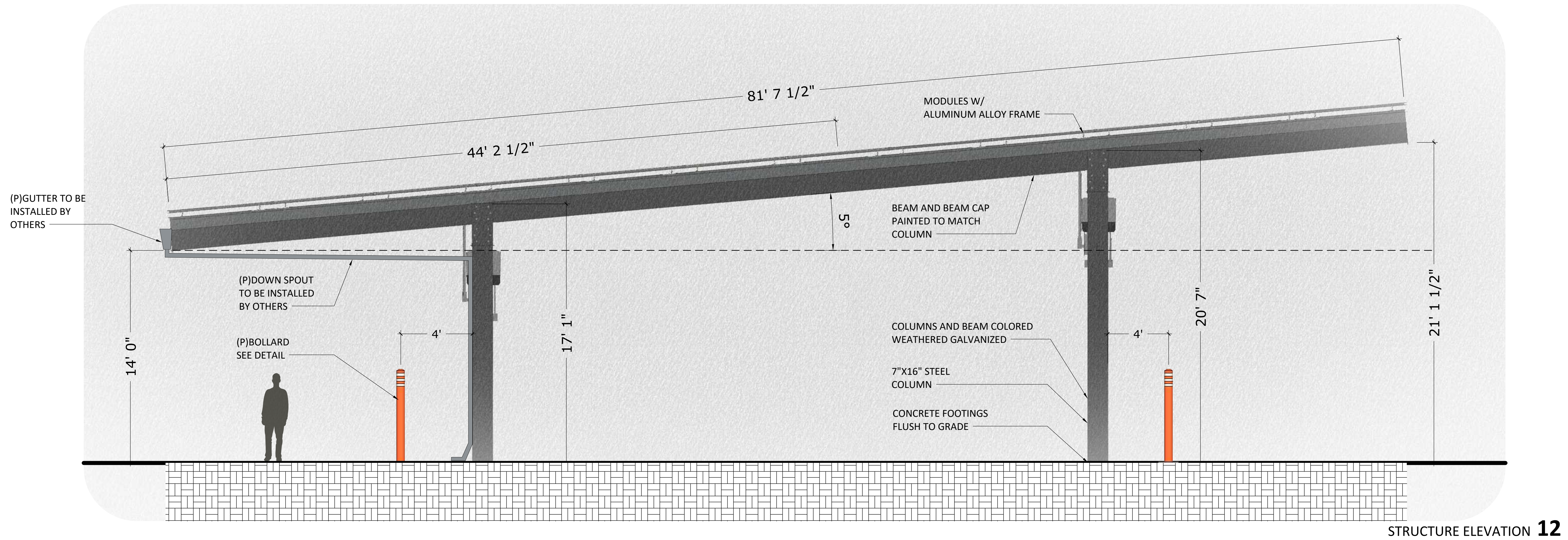

STRUCTURE ELEVATION 12

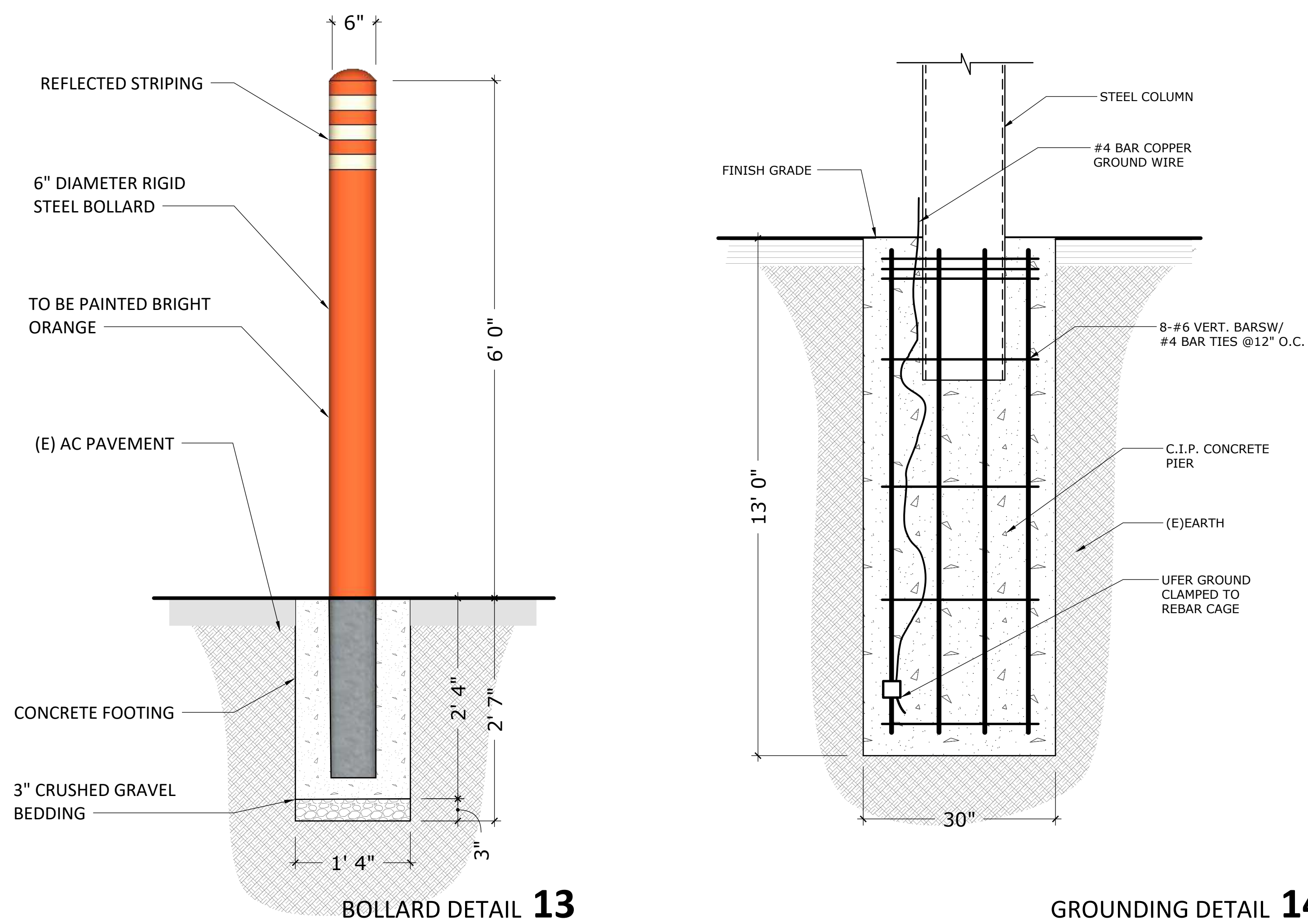

BOLLARD DETAIL 13

GROUNDING DETAIL 14

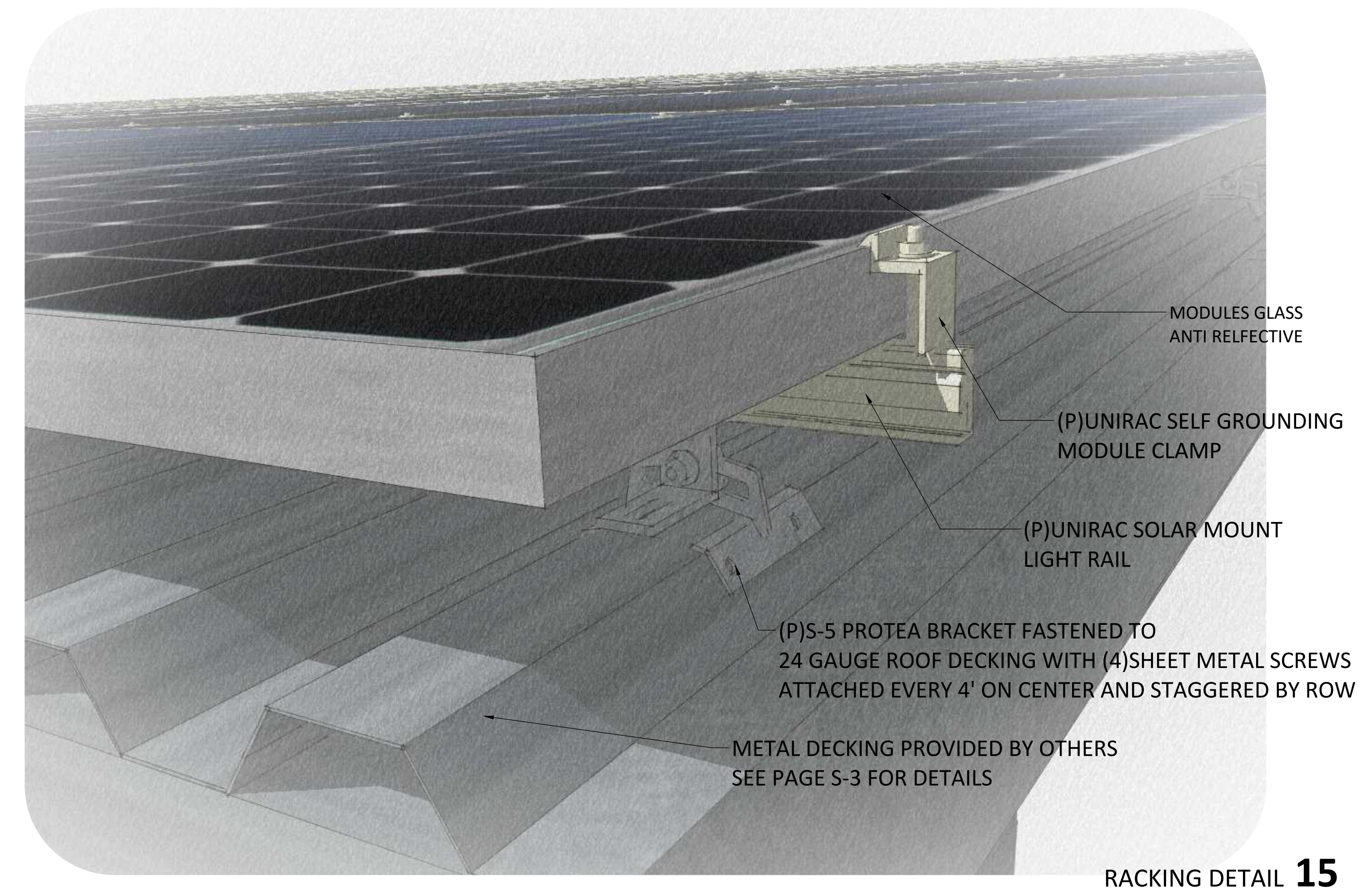

RACKING DETAIL 15

13620 HWY 99  
CHICO, CA 95973  
PHONE#: (530) 345-6980  
FAX#: (530) 892-2360  
info@solarenergyforlife.com



BUTTE COUNTY ASSOCIATION OF GOVERNMENTS  
326 HUSS LANE  
CHICO, CA 95920  
APN# 039-060-142  
CITY OF CHICO

SCALE: 1/16"=1'  
DATE MODIFIED: November 20, 2017  
DATE CREATED: December 9, 2015  
DESIGNER: E. TRITTEN  
CONSULTANT: C. ALMAGUER

PV-4.2  
ARCHITECTURAL  
DETAIL

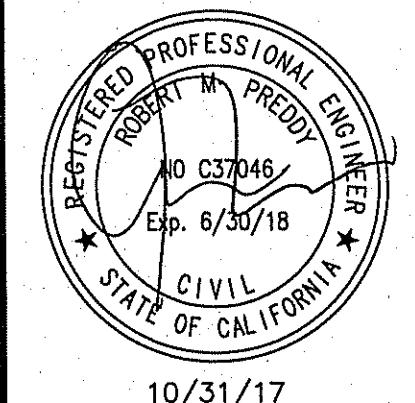

10/31/17

**ROOF FRAMING PLANS**

**FT & BACK to BACK FT SSS**  
Butte County Assoc. of Government

326 Huss Lane, Chico Ca.  
for: Alternative Energy Systems

**BAJA**  
**CONSTRUCTION CO., INC.**  
223 FOSTER ST., MARTINEZ CA 94553  
1-800-366-9600 FAX: (925) 229-0161

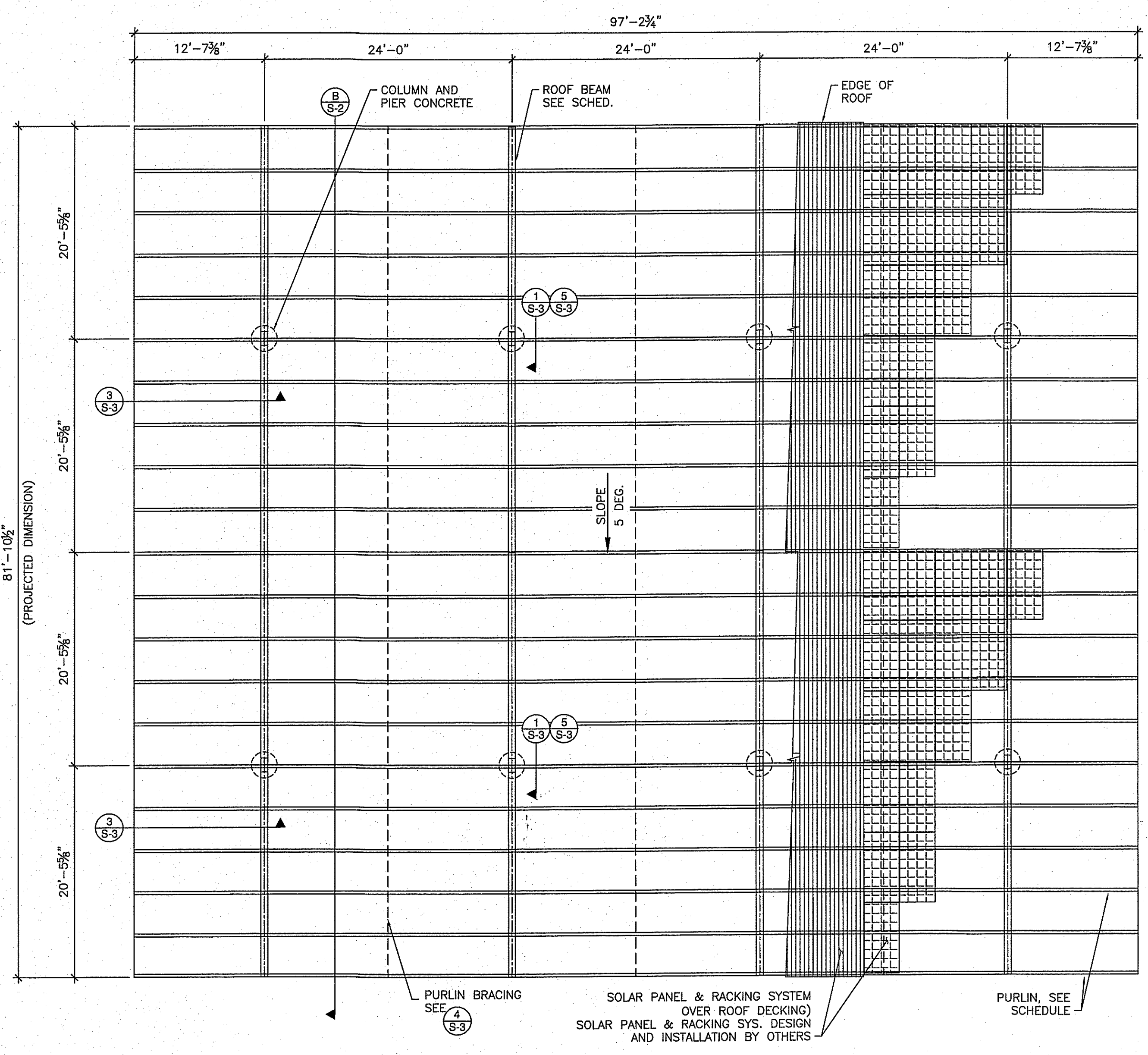

**ROOF FRAMING PLAN**  
(BLDG. 3) 1/8"=1'-0"

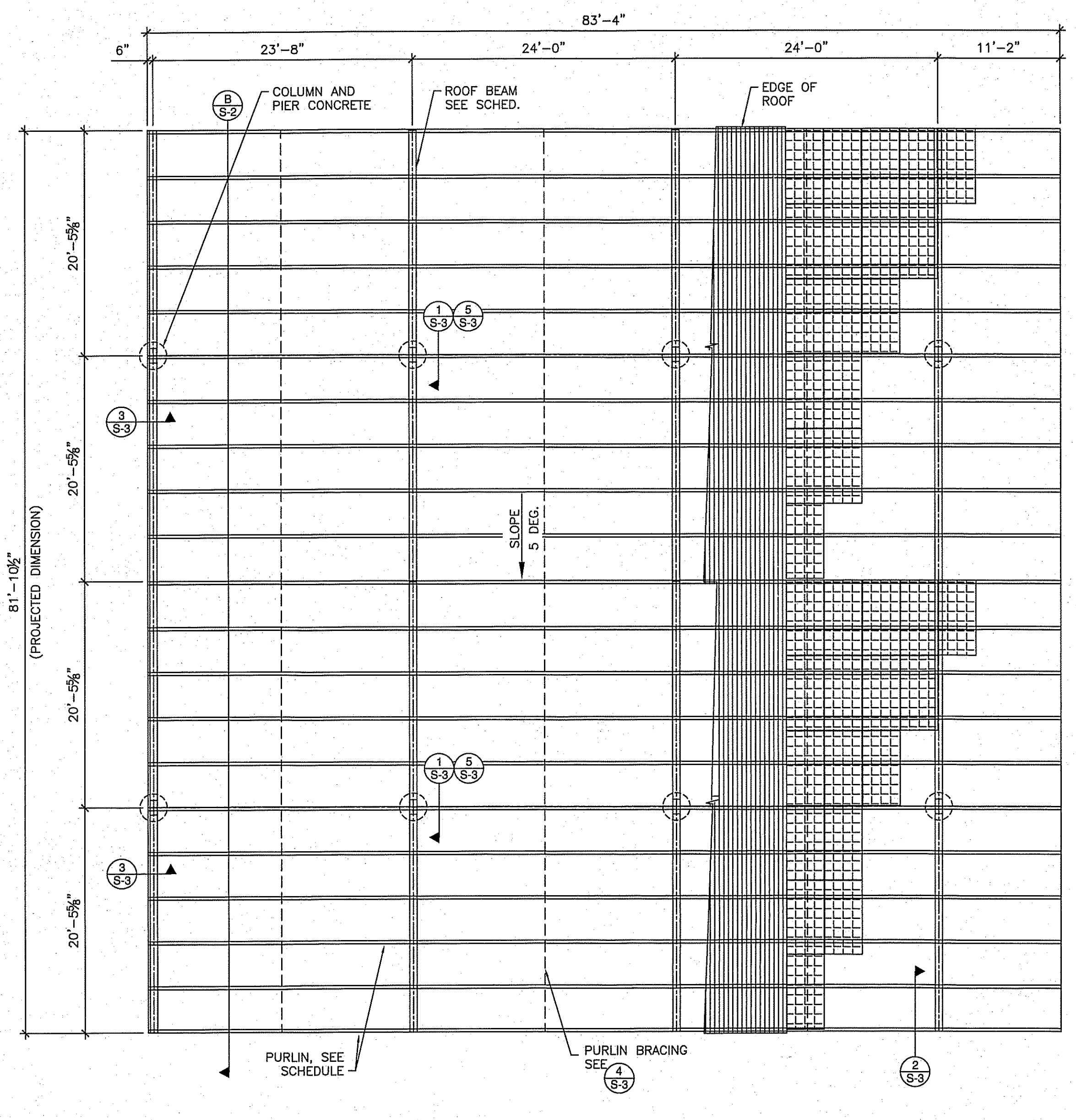

**ROOF FRAMING PLAN**  
(BLDG. 2) 1/8"=1'-0"

REV. NO.	DATE	DESCRIPTION
1	10/31/17	DDY Deleted 40.0' wide structures

PROJ. NO.:	DATE:
16-0339-A	09/20/17
DRAWN:	CHECKED:
DDY	R.P.

SHEET: **S-1**

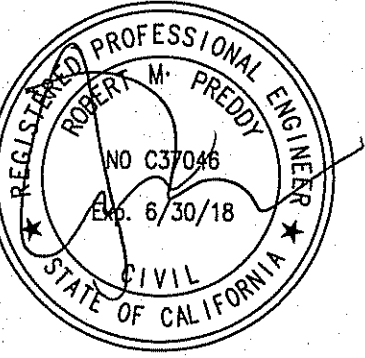

10/31/17

GEN. STRUCT. NOTES  
CROSS SECTION  
SCHEDULE

FT & BACK TO BACK FT SSS  
Butte County Assoc. of Government.

326 Huss Lane, Chico, CA.  
for: Alternative Energy Systems

**BAJA**  
CONSTRUCTION CO., INC.  
223 FOSTER ST., MARTINEZ CA 94553  
1-800-366-9600 FAX: (925) 229-0161

PROJ. NO.: 16-0339-A	DATE: 09/20/17
DRAWN: DDY	CHECKED: R.P.
SHEET: <b>S-2</b>	

GENERAL STRUCTURAL NOTES:

- CODE  
2016 CALIFORNIA BUILDING CODE.  
2007 NAS-AISI COLD-FORMED STEEL DESIGN MANUAL.  
WITH 2010 SUPPLEMENT.
- LOADS  
BUILDING OCCUPANCY CATEGORY II  
ROOF LIVE LOAD: 20 PSF (REDUCIBLE)  
BASIC WIND SPEED (3-SECOND GUST): 110 MPH, EXP. "C"  
WIND IMPORTANCE FACTOR = 1.0  
Kz = 0.85    Kzt = 1.0 G = 0.85  
COMPONENTS AND CLADDING:  
ZONE 1: p1=+28.78 PSF    p1=-25.51 PSF  
ZONE 2: p2=+43.18 PSF    p2=-38.60 PSF  
ZONE 3: p3=+57.57 PSF    p3=-76.54 PSF  
SEISMIC DESIGN CATEGORY "D"  
SEISMIC IMPORTANCE FACTOR = 1.0  
SITE CLASS "D"    Ss = 0.615    S1 = 0.273  
SEISMIC FORCE RESISTING SYSTEM: CANTILEVERED COLUMN  
ANALYSIS PROCEDURE: EQUIVALENT LATERAL FORCE  
DESIGN BASE SHEAR = 0.4290W
- FOUNDATION  
FOUNDATION DESIGN BASED ON AN ALLOWABLE SOIL BEARING PRESSURE OF 1500 PSF  
AND PASSIVE PRESSURE OF 100 PSF/FT PER CBC TABLE 1806.2, SOIL CLASS 5.
- CONCRETE  
ALL CONCRETE REQUIRED HERE-IN SHALL BE DONE IN ACCORDANCE W/ ACI STANDARD  
318-14, SPECIFICATIONS FOR STRUCTURAL CONCRETE FOR BUILDINGS, WHICH IS HEREBY MADE  
A PART OF THESE DOCUMENTS, WITH THE FOLLOWING MODIFICATIONS:  
PARA 2.1.2: CEMENT SHALL COMPLY W/ ASTM C150, TYPE II.  
PARA 3.2: F'c SHALL BE 2500 PSI AT 28 DAYS FOR ALL CONCRETE.  
PARA 4.1.3: THE USE OF EARTH CUTS FOR FORMS IS PERMITTED.  
PARA 5.2: REINFORCING SHALL BE NEW BILLET STEEL COMPLYING W/ ASTM A615, GRADE 40.  
SOLAR PANELS AND RACKING SYSTEM OVER STEEL ROOF DECK:  
SOLAR PANELS AND RACKING SYSTEM SHALL BE DESIGNED, SUPPLIED AND INSTALLED  
BY OTHERS (NOT BY BAJA CONSTRUCTION)
- STEEL ROOF DECK SHALL BE AEP SPAN "HR-36" (APMO=ESR-309) OR EQUAL PANEL,  
CONFORMING TO AISI-NAS COLD FORMED STEEL DESIGN MANUAL SPECIFICATION AS REFERENCED  
BY THE UBC: ASTM A702, ASTM A553 OR ASTM 511 WITH A MINIMUM YIELD STRENGTH OF  
80 KSI, AND MINIMUM TENSILE STRENGTH OF 82 KSI.
- LIGHT GAUGE STRUCTURAL STEEL FRAMING  
ALL LIGHT GAUGE STEEL FRAMING MEMBERS TO BE SUPPLIED BY ASC PROFILES (AEP SPAN),  
CLARK COUNTY APPROVED FABRICATOR ID# 628, CITY OF LOS ANGELES APPROVED FABRICATOR  
ID#1892 OR OTHER MANUFACTURERS W/ EQUIVALENT QUALIFICATIONS.  
ALL STRUCTURAL STEEL FRAMING MATERIALS AND ERECTION SHALL BE IN ACCORDANCE WITH  
THE LATEST EDITION OF THE AMERICAN IRON AND STEEL INSTITUTE "SPECIFICATIONS FOR THE  
DESIGN OF COLD-FORMED STEEL STRUCTURAL MEMBERS", ASTM A553 OR ASTM A570 WITH A  
MINIMUM YIELD STRENGTH Fy=55 KSI AND MINIMUM TENSILE STRENGTH Fu=65 KSI  
ALL WELDING SHALL CONFORM TO THE REQUIREMENTS OF THE LATEST EDITION OF THE AWS  
D1.1 "STRUCTURAL WELDING CODE - STEEL" AND AWS D1.3 "STRUCTURAL WELDING CODE -  
SHEET STEEL". REINFORCING BARS WELDED TO STEEL SHALL CONFORM TO ASTM A706 AND  
AWS D1.4 "STRUCTURAL WELDING CODE - REINFORCING STEEL". USE E70xx LOW HYDROGEN  
ELECTRODES. ALL WELDING TO BE PERFORMED BY WELDERS HOLDING A VALID CERTIFICATE  
AND HAVING CURRENT EXPERIENCE IN LIGHT GAUGE STEEL. CERTIFICATES SHALL BE ISSUED BY  
AN ACCEPTED TESTING AGENCY. DO NOT DRILL OR NOTCH MEMBERS WITHOUT PRIOR  
APPROVAL OF THE STRUCTURAL ENGINEER.  
STRUCTURAL STEEL MEMBERS SHALL BE FURNISHED TO THE SPECIFIED MINIMUM YIELD POINT  
OR GREATER. THE ASTM, GRADE, AND OTHER SPECIFICATIONS SHALL BE INDICATED BY  
SUITABLE MEANS ON EACH LIFT OR BUNDLE OF FABRICATED MATERIAL.
- FASTENERS  
STEEL SCREW FASTENERS SHALL BE ITW BULDEX SELF-DRILLING SCREWS (ESR-1976) OR  
EQUAL, COMPLYING WITH THE REQUIREMENTS OF THE CBC.
- CONTRACTORS  
THE CONTRACTOR MUST SUBMIT IN WRITING ANY REQUEST FOR MODIFICATIONS TO THE PLANS  
AND SPECIFICATIONS. NO STRUCTURAL CHANGES FROM THE APPROVED PLANS SHALL BE MADE  
IN THE FIELD UNLESS PRIOR WRITTEN APPROVAL IS OBTAINED FROM THE ENGINEER. SHOP  
DRAWINGS SUBMITTED TO THE ENGINEER FOR HIS REVIEW DO NOT CONSTITUTE "IN WRITING"  
UNLESS IT IS NOTED THAT SPECIFIC CHANGES ARE BEING REQUESTED. IF CHANGES ARE MADE  
WITHOUT WRITTEN APPROVAL, SUCH CHANGES SHALL BE THE LEGAL AND FINANCIAL  
RESPONSIBILITY OF THE CONTRACTORS OR SUBCONTRACTORS INVOLVED AND IT SHALL BE THEIR  
RESPONSIBILITY TO REPLACE OR REPAIR THE CONDITION AS DIRECTED BY THE ENGINEER.  
CONTRACTOR SHALL PROVIDE ALL TEMPORARY BRACING, SHORING, GUYING, OR OTHER MEANS  
TO AVOID EXCESSIVE STRESSES AND TO HOLD STRUCTURAL ELEMENTS IN PLACE DURING  
ERECTION. THESE PROVISIONS SHALL REMAIN IN POSITION UNTIL SUFFICIENT PERMANENT  
MEMBERS ARE ERECTED TO INSURE THE SAFETY OF THE PARTIALLY ERECTED STRUCTURES.  
THE CONTRACT STRUCTURAL DRAWINGS AND SPECIFICATIONS REPRESENT THE FINISHED  
STRUCTURE. OBSERVATION VISITS TO THE SITE BY THE STRUCTURAL ENGINEER SHALL NOT  
INCLUDE INSPECTION OF THE ABOVE ITEMS.
- ENGINEER OF RECORD  
BAJA CONSTRUCTION CO., INC. AND/OR THEIR ENGINEERING CONSULTANTS IS ONLY  
RESPONSIBLE FOR THE CONTENTS OF THESE DRAWINGS AND STRUCTURAL CALCULATIONS AS  
PROVIDED FOR THIS PROJECT. BAJA CONSTRUCTION CO., INC. AND THEIR ENGINEERING  
CONSULTANTS ARE NOT CONSIDERED THE ENGINEER OF RECORD FOR ANYTHING OTHER THAN  
THE PREFABRICATED STEEL SYSTEM CANOPY/CARPORT/RV & BOAT STORAGE/OR MINI-STORAGE  
SYSTEMS THAT IS SHOWN ON THESE PLANS.  
THESE PLANS ARE APPLICABLE ONLY TO THE SPECIFIC PROJECT NOTED ON THE PLANS. IN  
ADDITION, THESE PLANS ARE ONLY APPLICABLE TO THIS PROJECT PROVIDED BAJA  
CONSTRUCTION PROVIDES AND INSTALLS ALL MATERIAL SPECIFIED HEREIN.
- ALTERNATE FOOTING  
IF THE ALTERNATE FOOTING SHOWN IN THIS DRAWING IS REQUIRED, THERE WILL BE AN  
ADDITIONAL CHARGE FROM BAJA CONSTRUCTION.

SCHEDULE	
BUILDING (ARRAYS)	1, 2 & 3
MODEL NO.	BACK TO BACK TEE SOLAR
DEPTH OF CAR SPACE	81'-10 7/8"
BAY WIDTH	24'-0" (MAX)
SOLAR PANEL AND RACKING SYSTEM	SOLAR PANELS & RACKING SYSTEM DESIGNED, SUPPLIED & INSTALLED BY OTHERS "NOT BY BAJA CONSTRUCTIONS CO., INC."
ROOF DECK	HR-36 (AEP SPAN) x 26GA (Fy = 80 KSI)
ROOF PURLIN	CEE 12" x 3 1/2" x 12GA. WITH 11'-2" TO 12'-8" CANTILEVER
ROOF BEAM	(2) CEES 16" x 4" x10GA BOXED WITH #9 CORNER REINF BARS (Fy = 55 KSI)
COLUMN	(2) CEES 16" x 4" x10GA BOXED WITH #8 CORNER REINF BARS (Fy = 55 KSI) (@ LOW SIDE COLUMNS) (2) CEES 16" x 4" x10GA BOXED WITH #9 CORNER REINF BARS (Fy = 55 KSI) (@ HIGH SIDE COLUMNS)
CONCRETE PIER FOOTING UNCONSTRAINED CONDITION (Fin. Grade: Soil or Asphalt)	30" DIA. x 13'-0 DEEP
ALT. SPREAD FOOTING	6'-6" x 11'-0" x 36" DEEP w/ 17-#5 LONGITUDINAL REBARS & 28-#5 TRANSVERSE REBARS

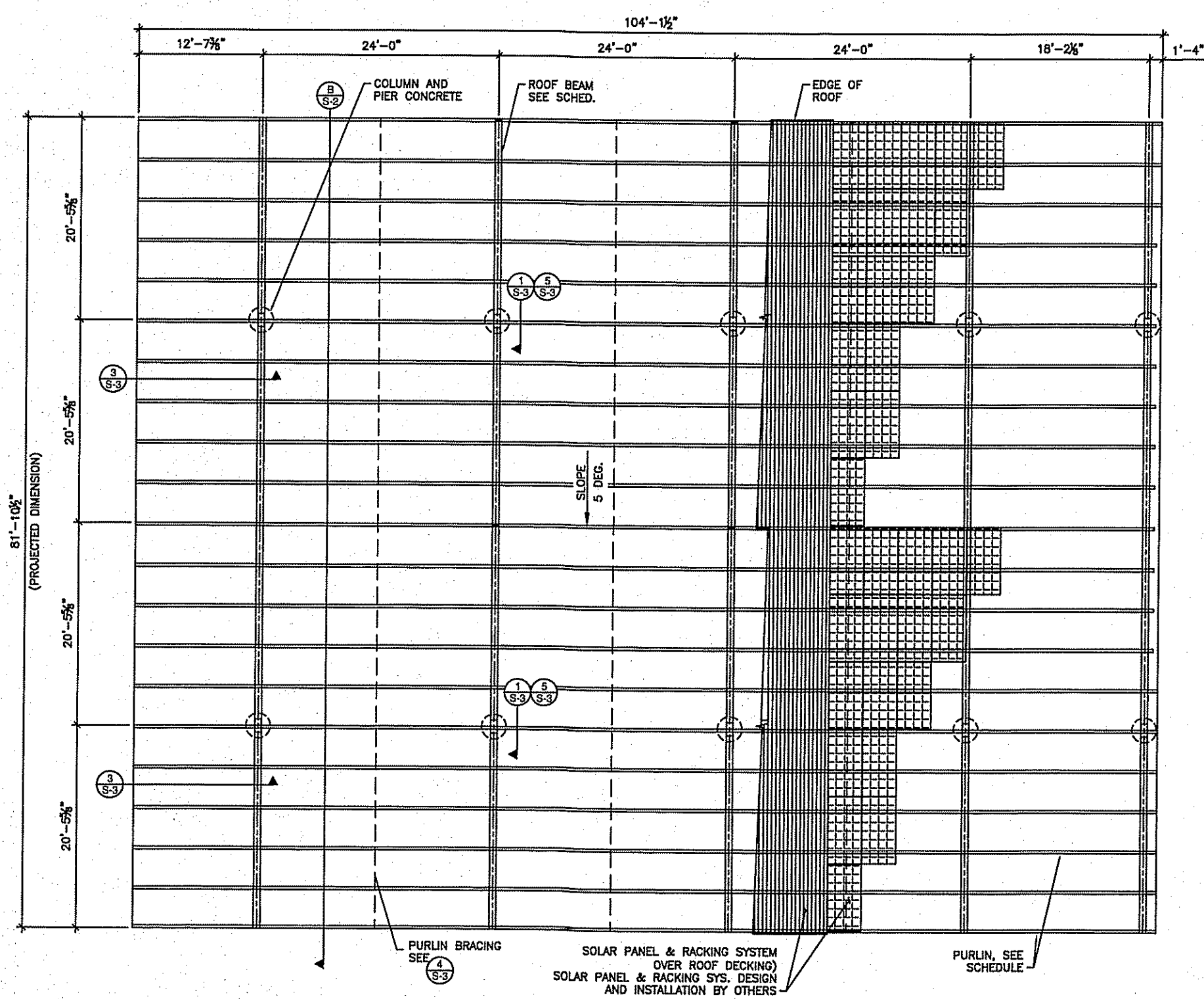

ROOF FRAMING PLAN  
(BLDG. 1)  
1/8"=1'-0"

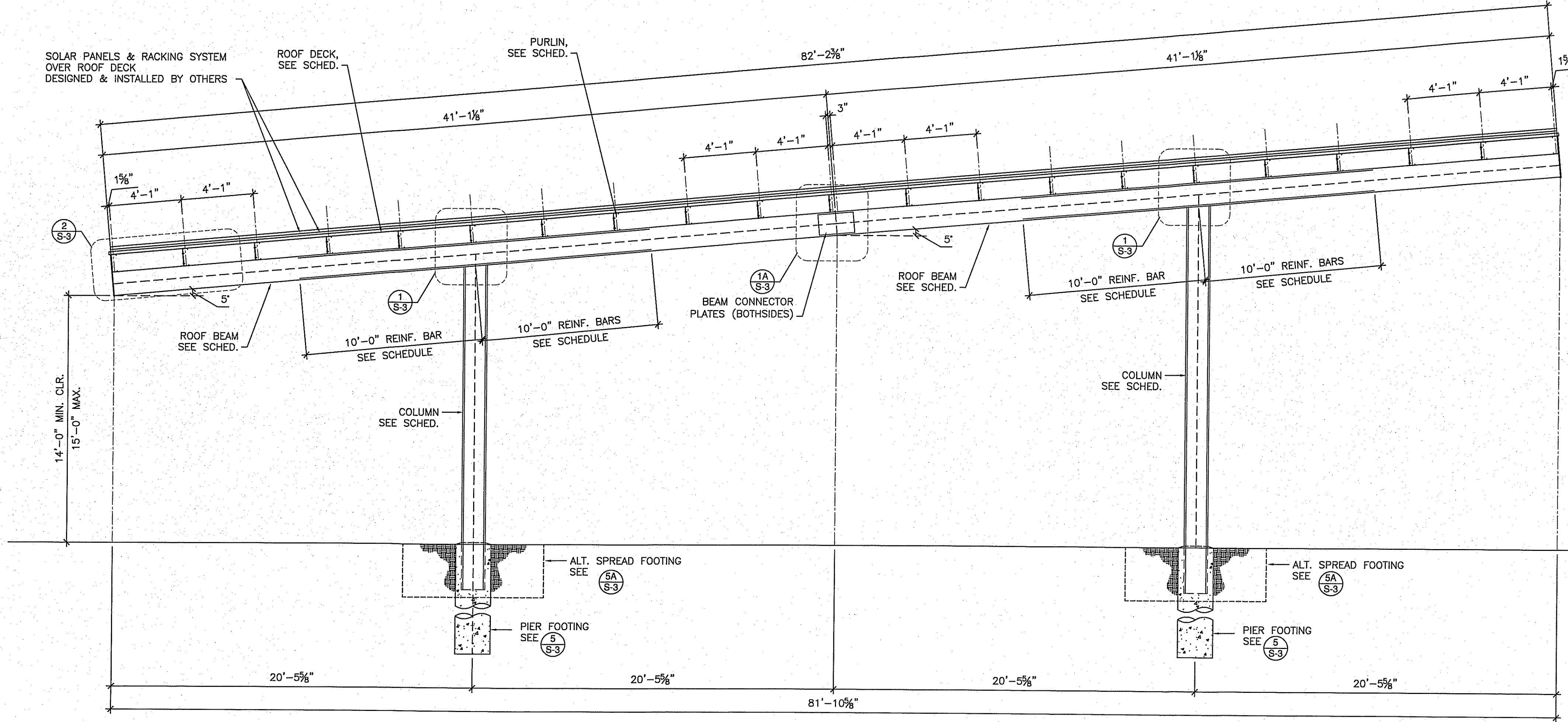

(B) CROSS SECTION  
1/4"=1'-0"

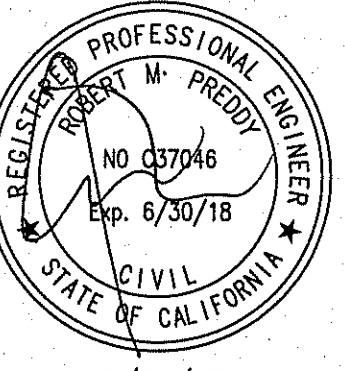

10/31/17

SECTIONS/DETAILS

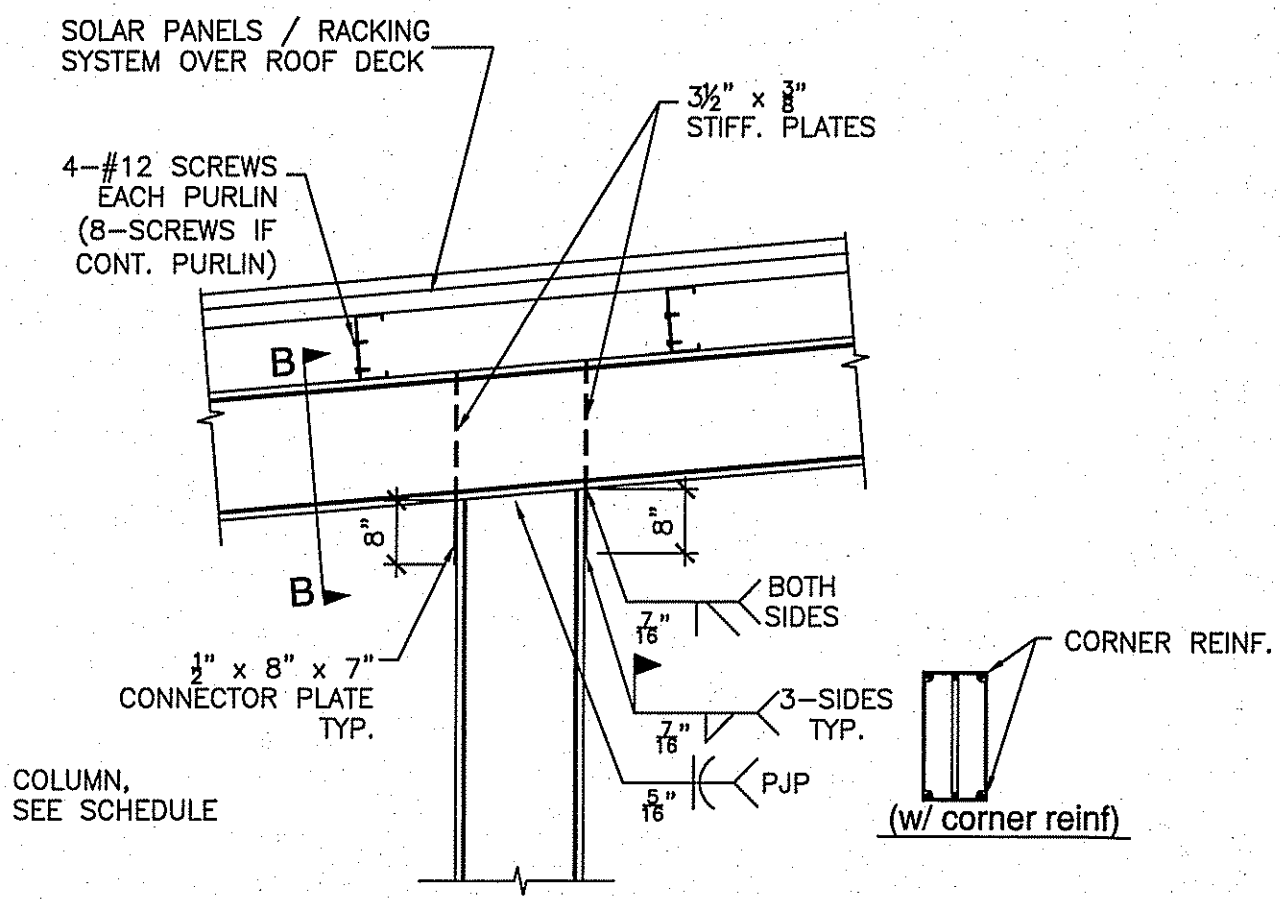

1 BEAM TO COLUMN CONNECTION N.T.S.

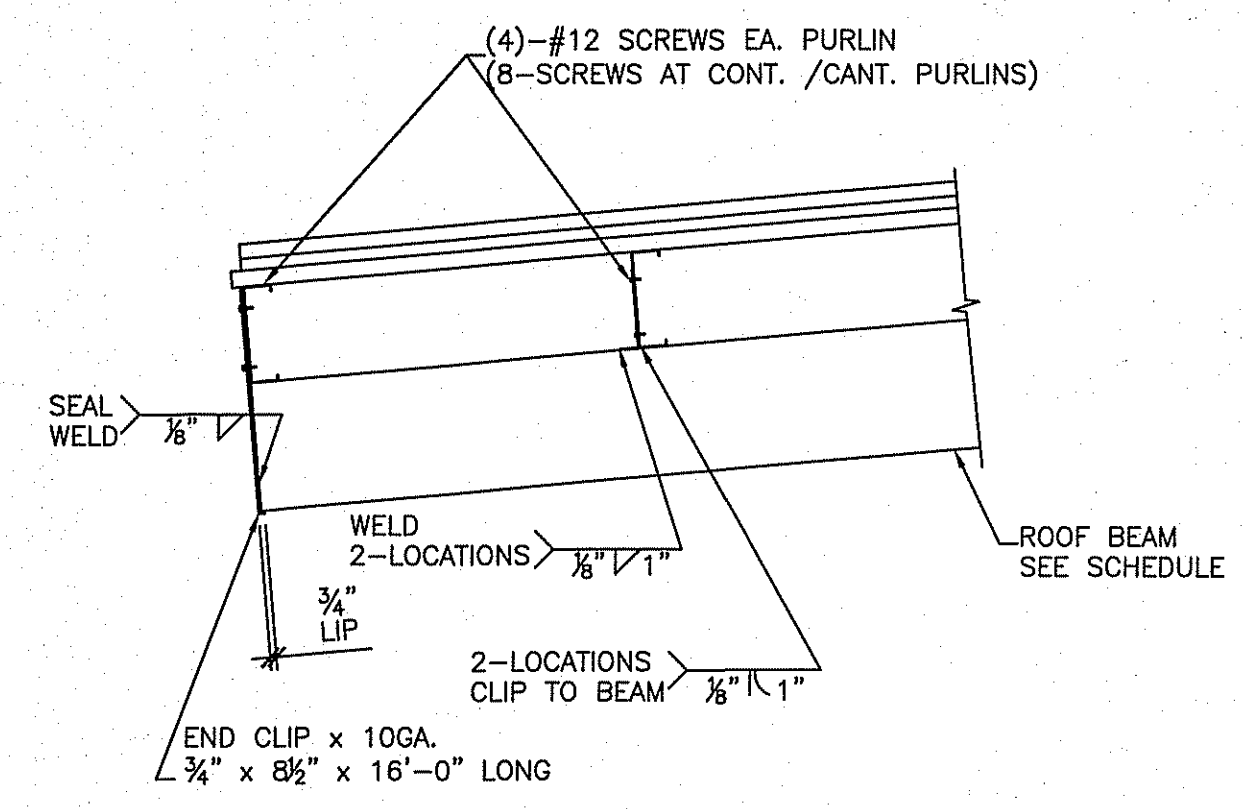

2 PURLIN TO BEAM CONNECTION N.T.S.

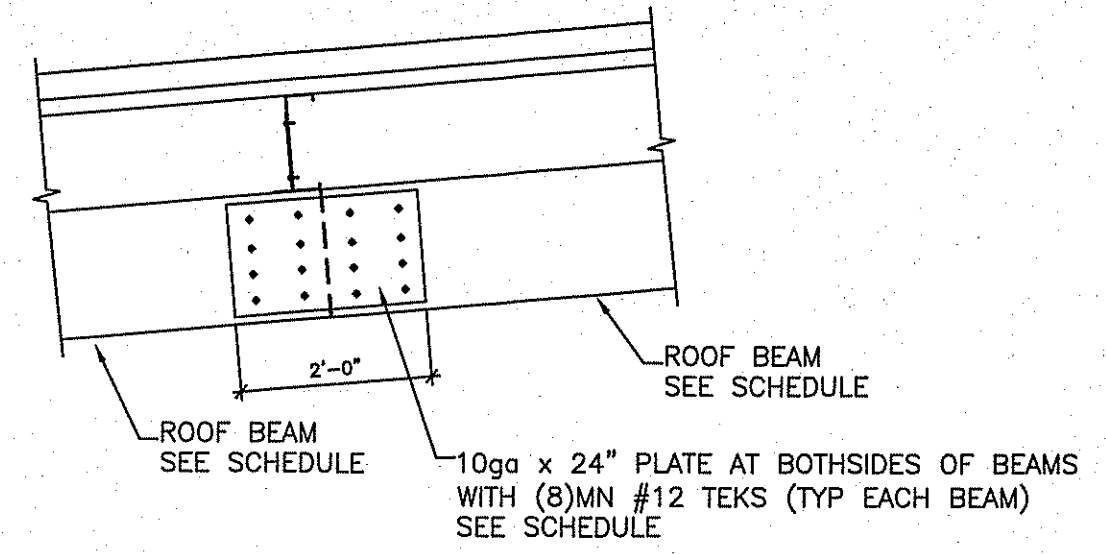

1A BEAM TO BEAM CONNECTOR PLATE N.T.S.

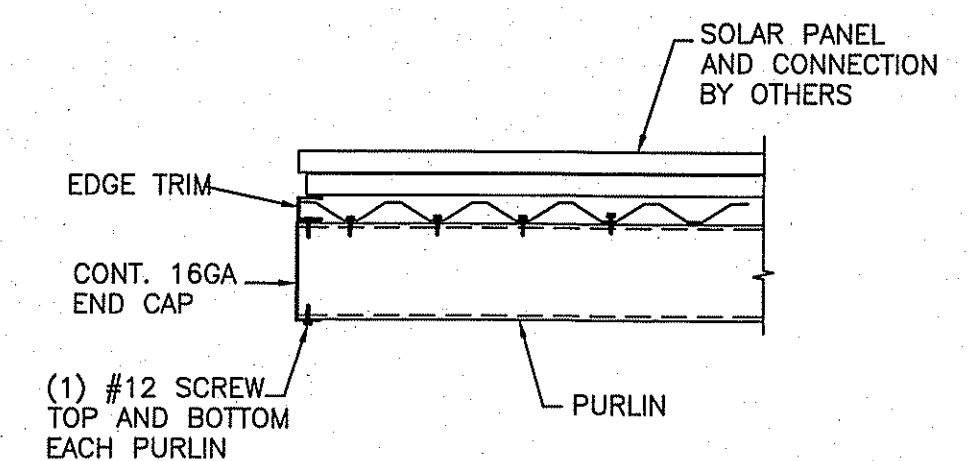

3 PURLIN CLOSURE N.T.S.

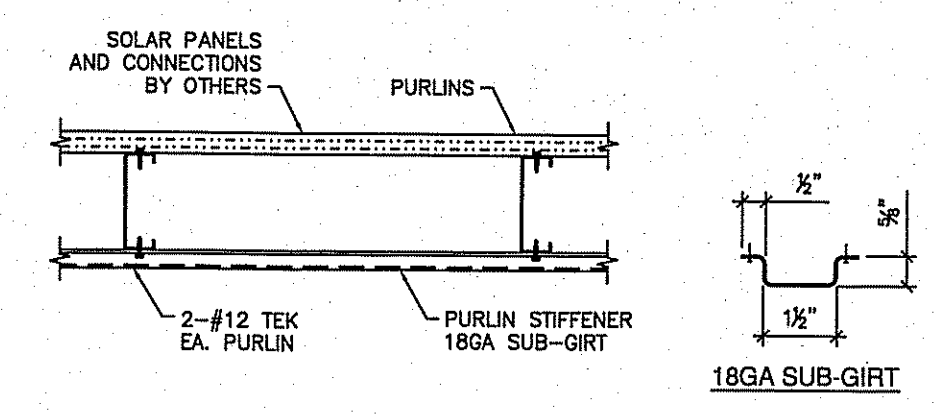

4 PURLIN BRACING N.T.S.

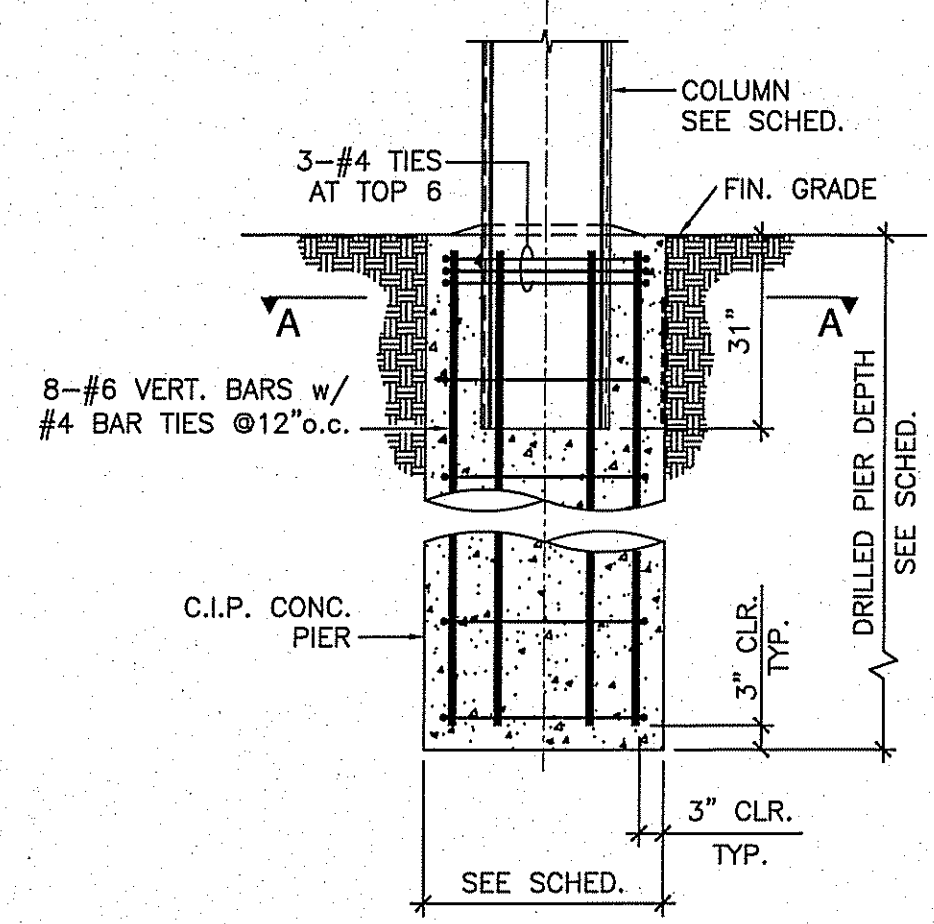

5 PIER FOOTING N.T.S.

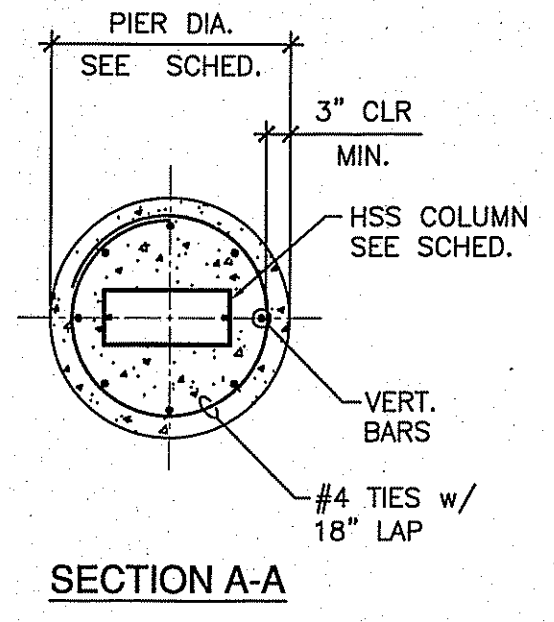

5A ALT. SPREAD FOOTING N.T.S.

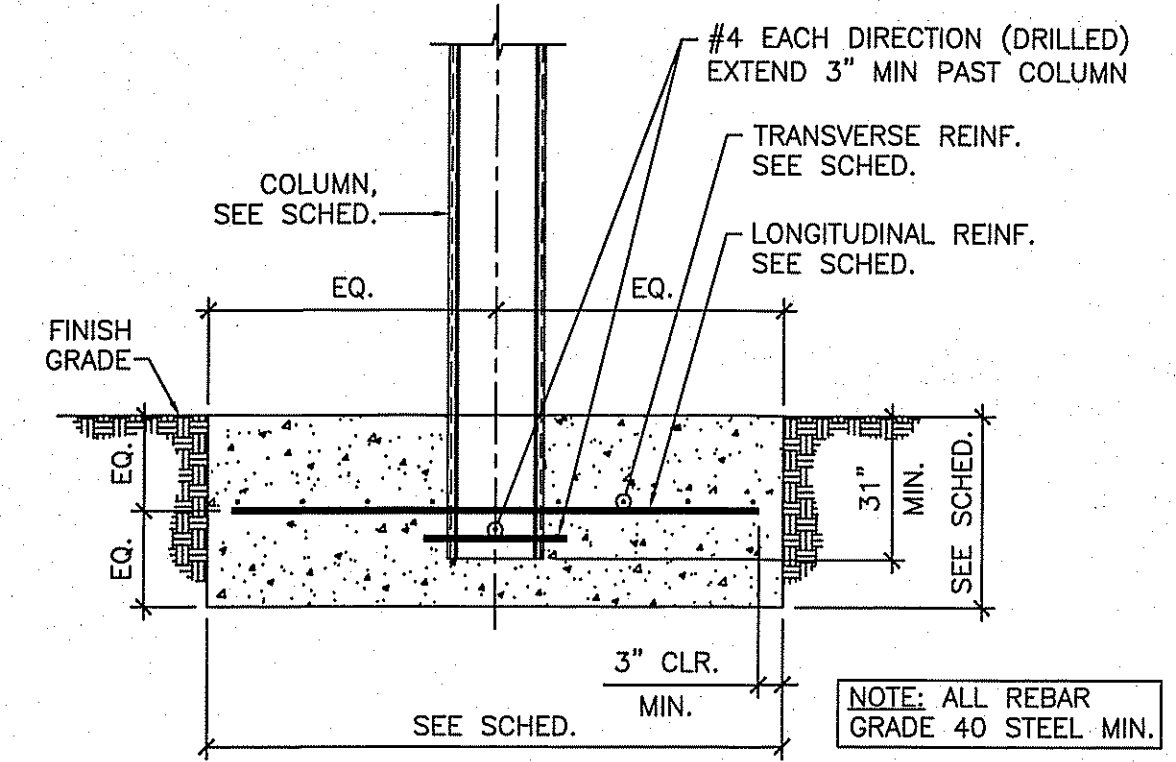

NOTE: ALL REBAR GRADE 40 STEEL MIN.

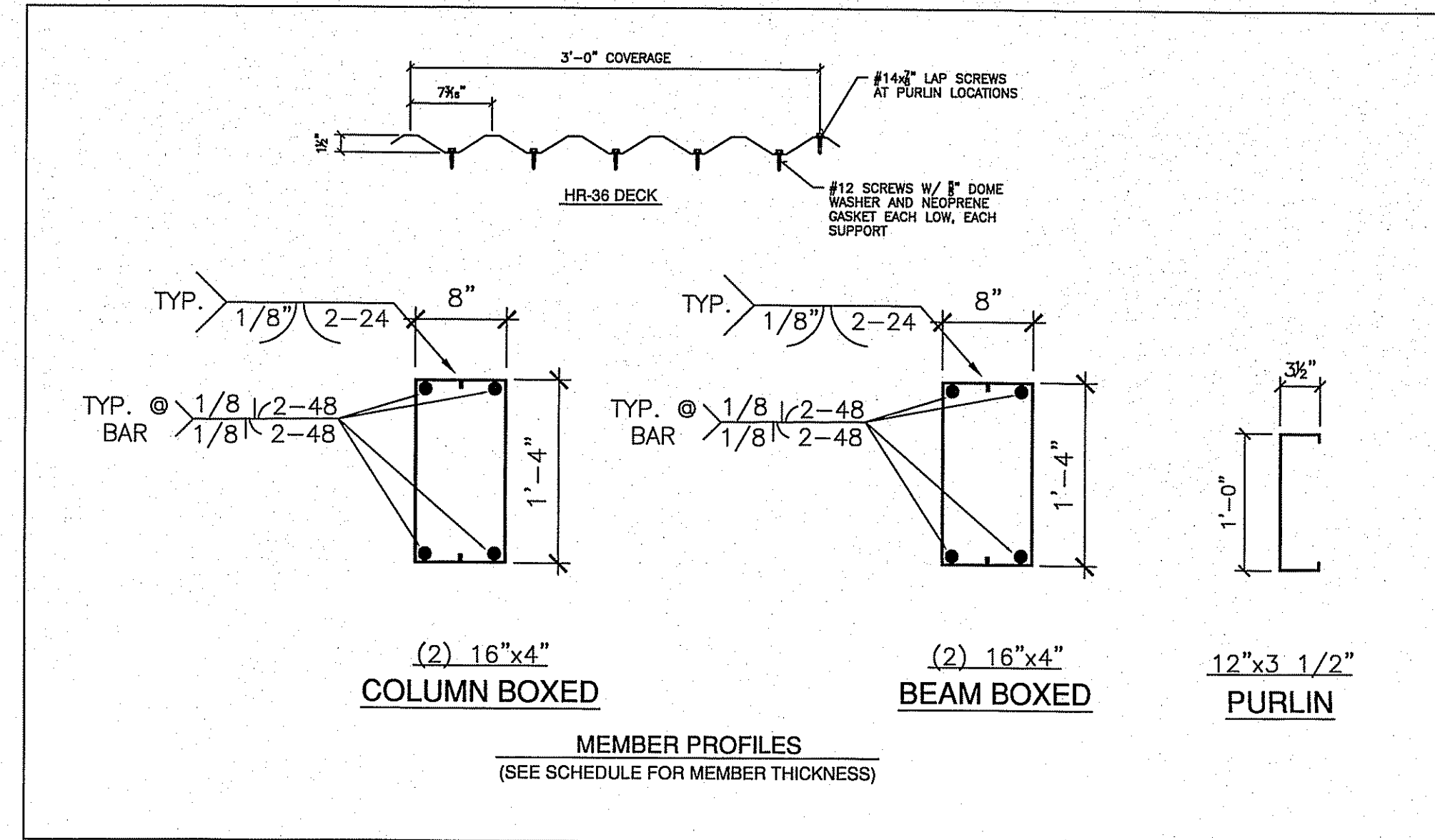

MEMBER PROFILES  
(SEE SCHEDULE FOR MEMBER THICKNESS)

FT & BACK to BACK FT SSS

Butte County Assoc. of Government  
326 Huss lane, Chico, Ca.  
for: Alternative Energy Systems

**BAJA**  
CONSTRUCTION CO., INC.  
223 FOSTER ST., MARTINEZ CA 94553  
1-800-366-9600 FAX: (925) 229-0161

REV. NO.	DATE	DESCRIPTION
Δ	10/31/17	DDY Deleted 40.0' wide structures

PROJ. NO.: 16-0339-A	DATE: 09/20/17
DRAWN: DDY	CHECKED: R.P.

**As Built Electrical**  
**Butte Regional Operations Center**





GHD Inc.  
2236 Mercury Way, Suite 150  
Santa Rosa, California 95407 USA  
T 1 707 523 1010 F 1 707 527 8679  
W www.ghd.com

**CONFORMANCE SET**  
IS FOR REFERENCE ONLY  
AND IS FURNISHED AS A  
CONVENIENCE. CONFORMANCE  
SET DOES NOT REPLACE  
THE CONTRACT DOCUMENTS  
OR THE CITY OF CHICO  
APPROVED PLANS AND SPECIFICATIONS



**B-Line**  
Butte Regional Transit

**Butte Regional  
Transit Operations  
Center**

326 HUSS DRIVE  
CHICO, CA 95928

**BUTTE COUNTY  
ASSOCIATION OF  
GOVERNMENTS**

PROJECT NUMBER  
11054.03

DATE  
9-12-14

DRAWN BY  
SEG

CHECKED BY  
CAR

REVISIONS

Number	Date	Description
1	7-8-14	PERMIT REVIEW
A1	7-14-14	ADDENDUM #1
A2	7-31-14	ADDENDUM #2
A3	8-6-14	ADDENDUM #3

**SITE ELECTRICAL PLAN**

**E1.1**

**BCAG B-LINE: BRTOC**  
BUTTE REGIONAL TRANSIT OPERATIONS CENTER

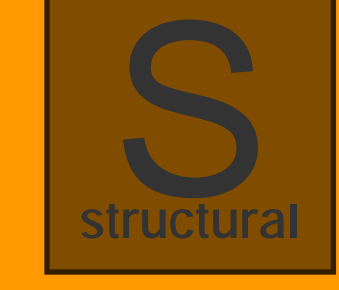

**SHEET GENERAL NOTES**

- CONTRACTOR SHALL COORDINATE THE PHASE 2 SITE IMPROVEMENTS WORK AFTER SUBSTANTIAL COMPLETION OF THE PHASE 1 SITE IMPROVEMENTS AND ONCE THE OWNER HAS MOVED ALL EXISTING OPERATIONS TO THE NEW FACILITIES.
- SITE LIGHTING IS SHOWN (SCREENED) ON THIS SHEET FOR REFERENCE ONLY. SEE E1.7 FOR SITE LIGHTING.
- REFER TO TRENCHING DETAIL 6.E5.1 FOR TYPICAL SECONDARY POWER AND SPECIAL SYSTEMS TRENCH/CONDUIT INSTALLATION.
- PROVIDE RIGID STEEL CONDUIT FOR ALL UNDERGROUND ELBOWS AND STUB-UPS PER DETAIL 6.E5.1.
- CONDUIT ENTERING BUILDINGS SHALL BE ROUTED UNDER FOOTINGS (NOT THRU FOOTINGS) AND TURNED UP UNDER THE DESTINATION EQUIPMENT/DEVICE.

**KEYNOTES**

- PROVIDE 1" C TO MAINTENANCE BUILDING FIRE ALARM PANEL FOR FIRE SERVICE VALVE MONITORING. REFER TO DETAIL 4.C5.3. SEE FIRE ALARM SYSTEM RISER DIAGRAM FOR CABLE TYPE.
- PROVIDE 1" C TO LOCAL BUILDING FIRE ALARM PANEL FOR FIRE SERVICE VALVE MONITORING. REFER TO DETAIL 4.C5.3. SEE FIRE ALARM SYSTEM RISER DIAGRAM FOR CABLE TYPE.
- NOTE DELETED.
- NOTE DELETED.
- PROVIDE NETWORK CABLE AND CONDUIT AS INDICATED BETWEEN IDF AND LIGHT POLE FOR INSTALLATION OF POLE MOUNT WIRELESS ACCESS POINT BY OTHERS. COORDINATE EXACT LENGTH REQUIRED TO REACH POLE TOP WITH IT CONTRACTOR.
- GATE OPERATOR. REFER TO DETAIL 1.C6.4 FOR ADDITIONAL DETAILS. PROVIDE CONDUITS AND POWER AS INDICATED FOR A COMPLETE AND OPERATIONAL SYSTEM. ACCESS CONTROL WIRE SHALL BE PROVIDED IN DESIGNATED SECURITY CONDUIT BY OWNER'S SECURITY CONTRACTOR.
- GATE OPERATOR. REFER TO DETAIL 1.C6.4 FOR ADDITIONAL DETAILS. PROVIDE CONDUITS AND POWER AS INDICATED FOR A COMPLETE AND OPERATIONAL SYSTEM. POWER SHALL BE FED FROM SPARE CIRCUIT IN EXISTING BUILDING. ACCESS CONTROL WIRE SHALL BE PROVIDED IN DESIGNATED SECURITY CONDUIT BY OWNER'S SECURITY CONTRACTOR.
- SWING GATE. PROVIDE CONDUITS AND POWER AS INDICATED FOR A COMPLETE AND OPERATIONAL SYSTEM. ACCESS CONTROL WIRE SHALL BE PROVIDED IN DESIGNATED SECURITY CONDUIT BY OWNER'S SECURITY CONTRACTOR.
- SWING GATE. PROVIDE CONDUITS AND POWER AS INDICATED FOR A COMPLETE AND OPERATIONAL SYSTEM. POWER SHALL BE FED FROM SPARE CIRCUIT IN EXISTING BUILDING. ACCESS CONTROL WIRE SHALL BE PROVIDED IN DESIGNATED SECURITY CONDUIT BY OWNER'S SECURITY CONTRACTOR.

**CONDUIT AND CABLE LEGEND**

- P1 (E) PG&E PRIMARY
- P2 PV SYSTEM 480V POWER - (2) 4" CO
- P3 GATE POWER CIRCUIT - (1) 1" C - (4) #10 & #10 GND
- P4 GATE POWER CIRCUIT - (1) 1" C - (4) #10 & #10 GND
- P5 (E) PG&E SECONDARY - (4) 5" CO. COORDINATE CONDUCTOR INSTALLATION WITH PG&E
- P6 SPARE - (1) 2" CO
- L1 SITE LIGHTING - (1) 2" C - (3) #8 & #8 GND TO LOCAL LCP
- S1 FIRE ALARM, SECURITY, AND ACCESS CONTROL BACKBONE - (3) 2" C - (1) 2" C. WIRING PER SECURITY / ACCESS CONTROL VENDOR REQUIREMENTS. (1) 2" C. FIRE ALARM CABLING PER FIRE ALARM RISER. (1) 2" CO
- S2 ACCESS CONTROL SITE CONDUIT - (2) 1" C - (1) 1" C. WIRING PER SECURITY / ACCESS CONTROL VENDOR REQUIREMENTS. (1) 1" CO.
- S3 FIRE ALARM - (1) 1" C - CABLING PER FIRE ALARM RISER
- T1 DATA SYSTEM BACKBONE - (2) 2" C - (1) 2" C WITH INNERDUCT, 12 STRAND MM FO CABLE, (1) 25-PAIR OSP COPPER CABLE - (1) 2" CO
- T2 AT&T SERVICE CONDUITS - (2) 4" CO
- T3 POLE-MOUNT WAP NETWORK CABLING - (1) 1" C WITH (2) CAT-5e OSP COPPER CABLE.
- AXXX-X FEEDER PER SCHEDULE ON E6.1
- C1 CATV SERVICE CONDUIT - (1) 2" CO

**SPECIAL SYMBOLS**

- (BXXYY)T PROVIDE CHRISTY PRECAST CONCRETE PULL BOX WITH BASE SLAB, EXTENSION RING, AND COVER. XX" WIDE BY YY" LONG (INTERNAL). PROVIDE TRAFFIC RATED COVER WHERE NOTED WITH A "T".

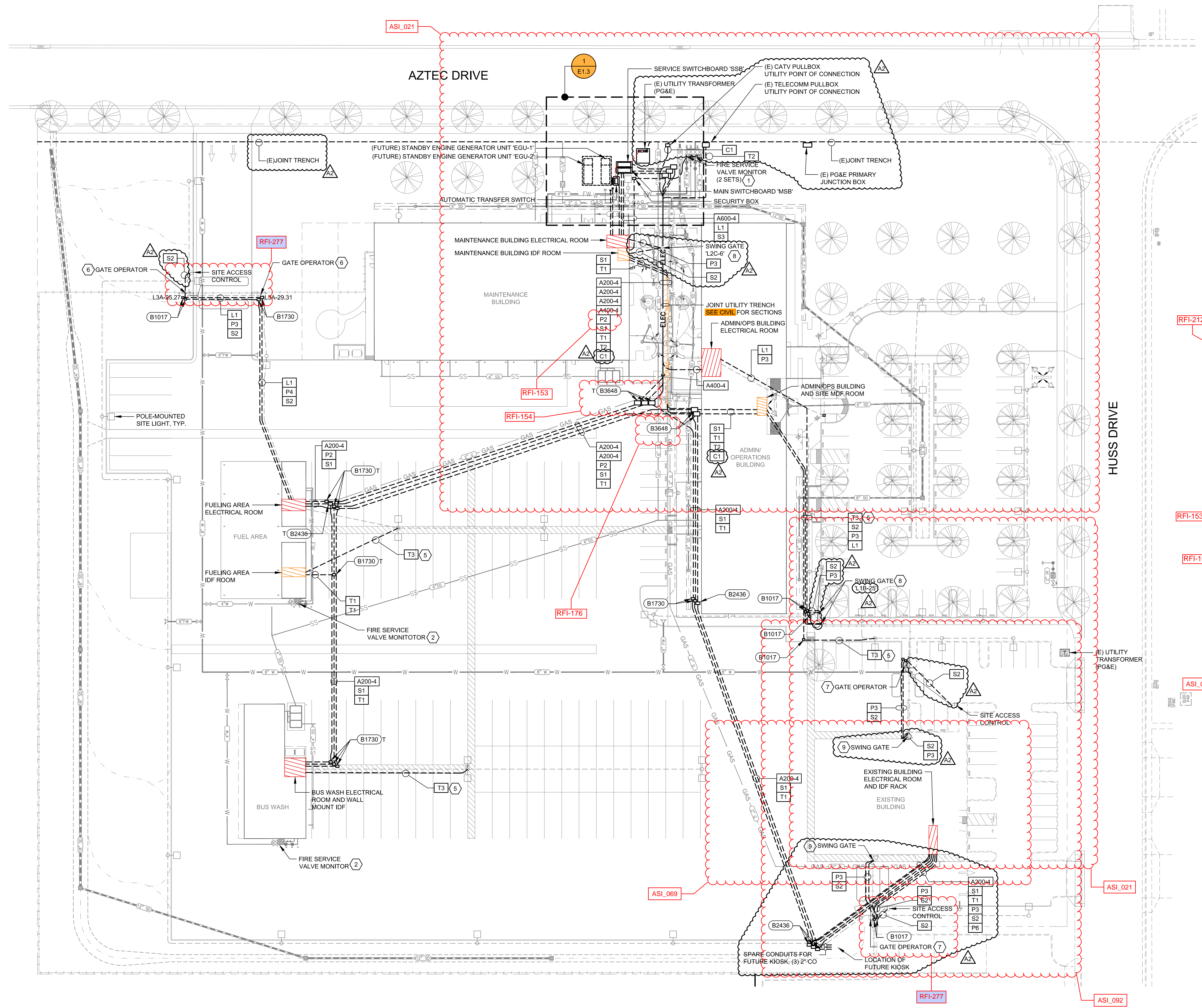
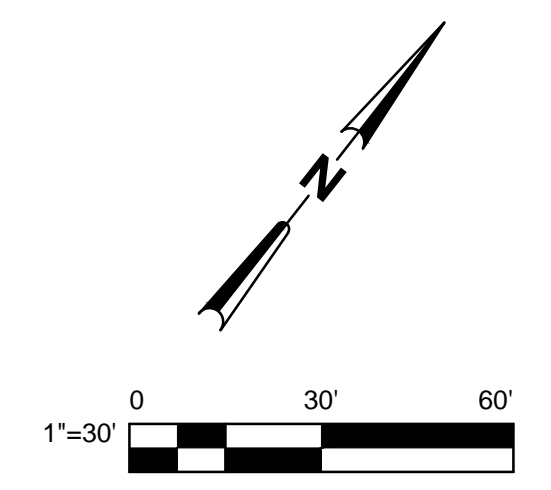

## **Desk Audit Loading Evaluations**

**EXISTING TRANSFORMER LOADING EVALUATION**

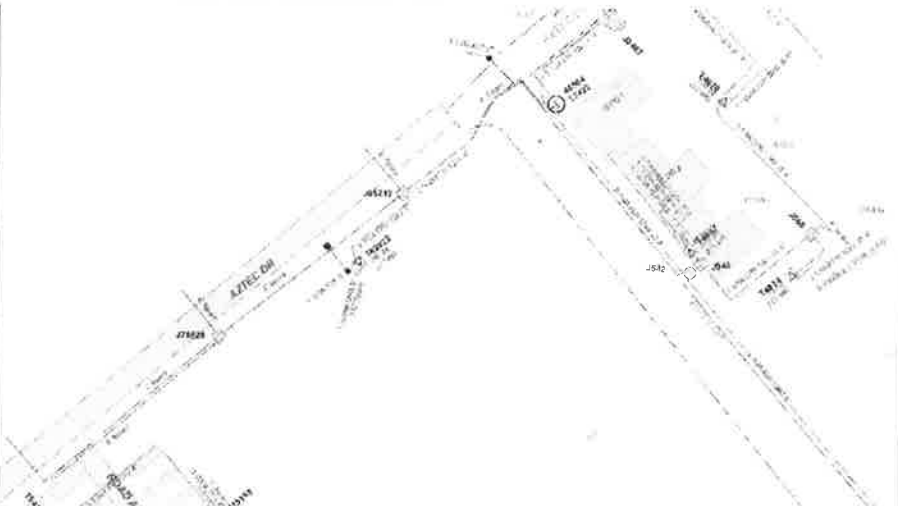
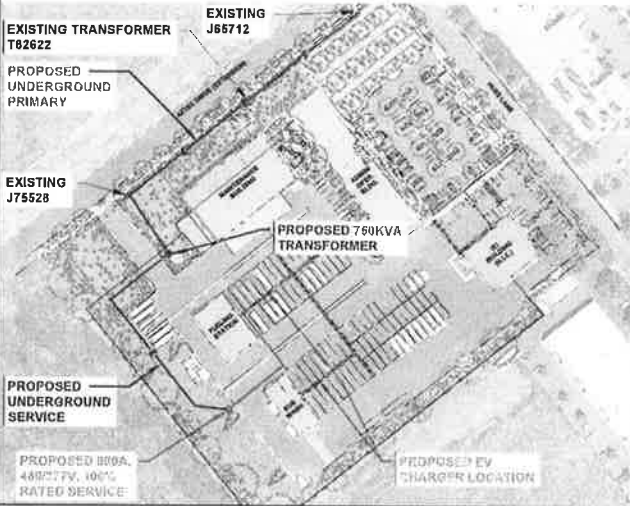

**VICINITY MAP**

**WEB VIEWER**

Peak Month	Winter		Summer	
	Qty	kVA	Qty	kVA
Nameplate kVA				
Calc. Capability (kVA)				
Calc. Peak Load (kVA)				
Percent Loading				
SM Customers / Total Customers		1/1		1/1
SM Ratio		100%		100%
Customer Type				
Domestic				
Commercial	1	126.7	1	198.8
Industrial				
Agricultural				
Other				

Data Start Date: 07/2016

Delivered  Start Month: 09/2018 Num of Months: 12  Retrieve Data

Peak kVA Demand: 198.8 Date Peaked: 07/27/2019 09:30 PM

Displaying "Delivered" Data for Start Month 09/2018 & for 12 Month(s)

Transformer Meter Ratios

Sep18	Oct18	Nov18	Dec18	Jan19	Feb19	Mar19	Apr19	May19	Jun19	Jul19	Aug19
1/1	1/1	1/1	1/1	1/1	1/1	1/1	1/1	1/1	1/1	1/1	1/1

Service Point Info

#	Conn	SM	Service Point ID	Meter #	Peak Timestamp	Peak kVA	kVA at Trf Peak	Interval	Customer Type	Address
1	Y	Y	1710061483	1006733910	07/27/2019 09:30 PM	198.8	198.0	15	COM	326 HUSS DR UNIT B

**TRANSFORMER LOADING**

EXISTING	SUMMER
PEAK SEASON	SUMMER
TRF LOADING AREA	INTERIOR
NAMEPLATE KVA	N/A
CALC. CAPABILITY**	N/A
CALC. PEAK LOAD	N/A

PROPOSED	CHARGER 1	CHARGER 2	CHARGER 3
TYPE	CHARGEPOINT	N/A	N/A
RATING (KW)	62.5	N/A	N/A
COUNT	10	N/A	N/A
CONNECTED (KW)	625	N/A	N/A
TOTAL KW	625	3PH AMPS	
DIVERSITY FACTOR	0.8	@VSEC L-L	
EV TRF DF LOAD	500		

CALC. PEAK + EV TRF DF LOAD	N/A	
RESULT TRF % LOADING	N/A	EXISTING TRF T82622 APPROXIMATELY 770% AWAY FROM NEW SERVICE. NEW TRF REQUIRED

NEW TRF NAMEPLATE KVA SIZE*	750
NEW TRF KVA CAPABILITY**	900
NEW TRF % LOADING	55.6%

**TRANSFORMER LOADING HISTORY**

TABLE 7 PAD-MOUNTED TRANSFORMER NORMAL CAPABILITY IN KVA

TRANSFORMER LOCATION AND SIZE	SUMMER INTERIOR		SUMMER COASTAL AND WINTER	
	RESIDENTIAL	NON-RESIDENTIAL	RESIDENTIAL	NON-RESIDENTIAL
	40% ANNUAL LOAD FACTOR	40%-80% ANNUAL LOAD FACTOR	40% ANNUAL LOAD FACTOR	40%-80% ANNUAL LOAD FACTOR
PAD-MOUNTED - THREE-PHASE 750KVA	900	900	1050	1050

**DISTRIBUTION TRANSFORMER CAPABILITY**

VEHICLE TYPE & MODEL: GILLIG AND TRANSIT BUS  
GILLIG 35' AND TRANSIT BUS 40'

CHARGER TYPE & MODEL: CHARGEPOINT CP250 (62.5KW) IS USED FOR CHARGER CALCULATION PURPOSES. THE EV REBATE POWER OUTPUT IS 150+ KW

NUMBER OF VEHICLES: (5) GILLIG 35' AND (5) TRANSIT BUS 45'

DESCRIPTION	2020	2021	2022	2023	2024
	YEAR 1	YEAR 2	YEAR 3	YEAR 4	YEAR 5
# OF VEHICLES	2	2	2	2	2
ANTICIPATED LOAD	125KW	125KW	125KW	125KW	125KW
# AND TYPE OF VEHICLE	2 TRANSIT BUS	2 TRANSIT BUS	1 GILLIG AND 1 TRANSIT BUS	2 GILLIG	2 GILLIG
# AND TYPE OF CHARGERS	2 @ 62.5KW	2 @ 62.5KW	2 @ 62.5KW	2 @ 62.5KW	2 @ 62.5KW

- ELECTRICAL EQUIPMENT TO BE INSTALLED:
- A. NEW 750KVA, 480/277V, PAD MOUNT TRANSFORMER
  - B. NEW 800A, 480/277V, 100% RATED SERVICE
  - C. PULL NEW PRIMARY IN EXISTING DUCT TO J75528

PG&E REGION	PG&E DIVISION	FEEDER NAME
NORTHERN	NORTH VALLEY	BUTTE 1104

DRAWN BY:	SHEET NO. 1
CHECKED BY:	
DATE: 11-18-2019	
NOT TO SCALE	
OF 1 SHEETS	

## Select EV Routing Analysis

Route						
	Average	Hot	Cold	Average	Hot	Cold
Route 2	185	156	181	257	218	241
Route 3 and 4	236	192	224	331	271	297
Route 5	231	189	217	322	266	289
Route 16 and 17	210	168	200	296	238	265
Route 20	210	192	201	299	274	276
Route 41	221	196	215	312	277	289

# Range Comparison

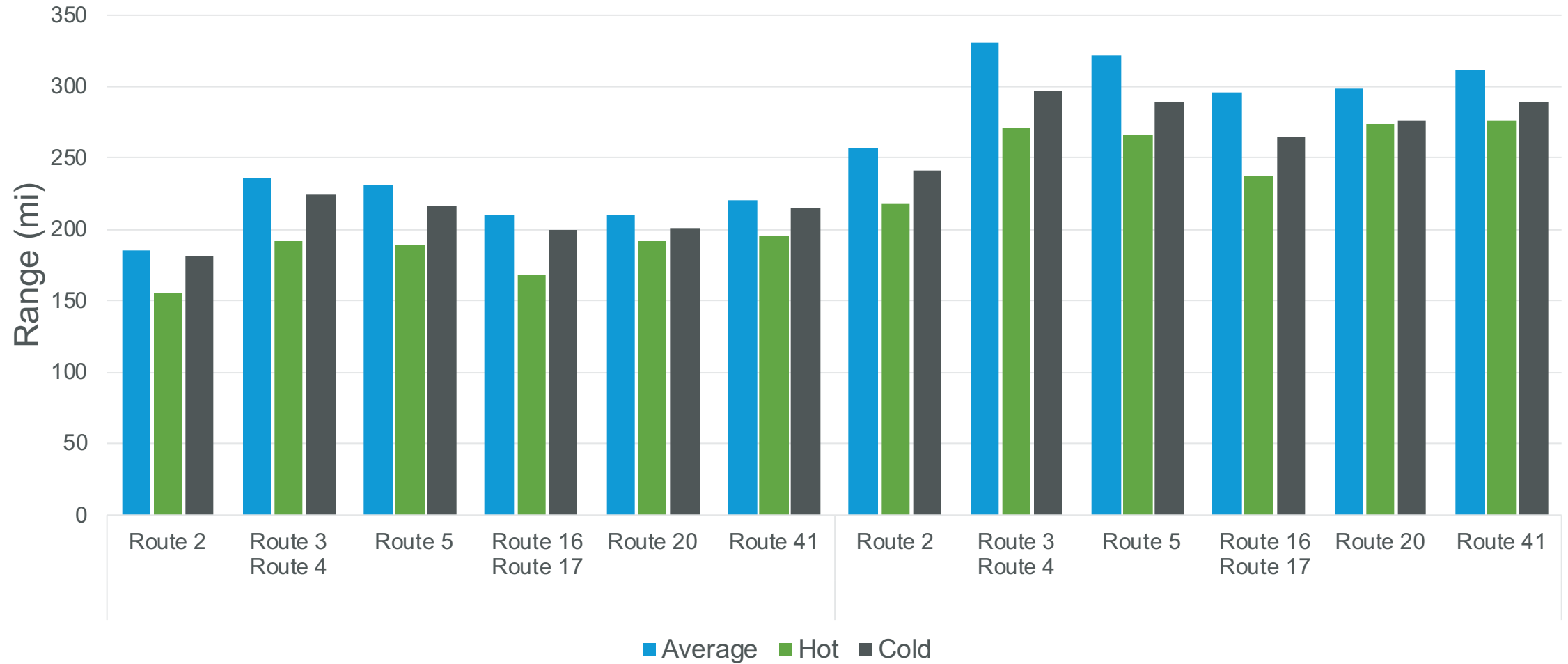

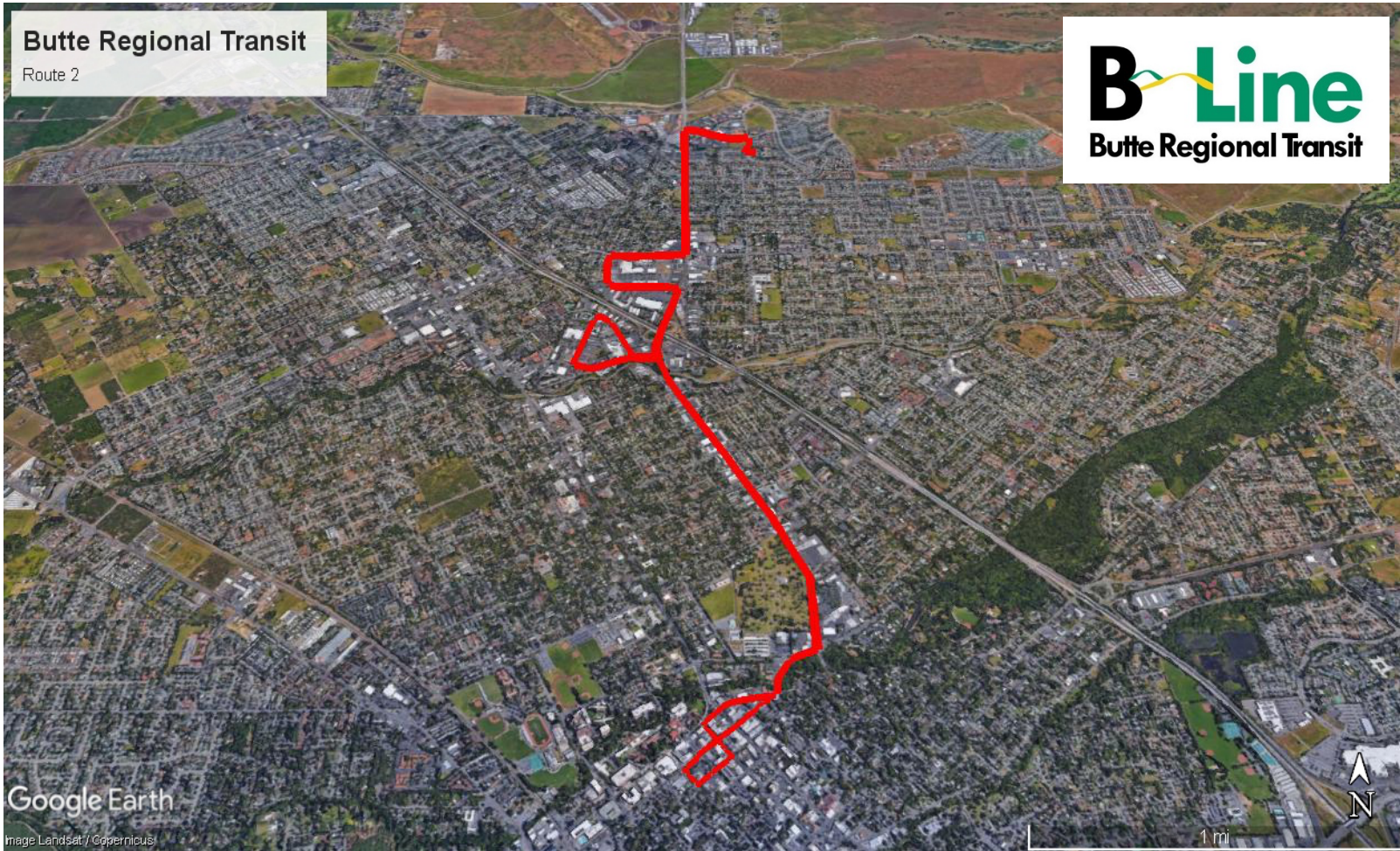

<b>Route Information</b>	
Route Name	<b>Route 2</b>
Distance	10.8 miles
Duration	48 minutes
Average Speed	14 MPH
Maximum Speed	39 MPH
Maximum Grade	2.5%
<b>Average Day Results</b>	
Passenger Count	40
Ambient Temperature	74°F
Efficiency	<b>2.214 kWh/mi</b>
MPGe	17
Total Energy Consumed	23.9 kWh
Estimated Range with 1 Full Charge	185 miles
System Energy Recaptured by Regen	28.6%
<b>Environmental and Operating Impact</b>	
<b>Hot Day</b>	
Passenger Count	40
Ambient Temperature	101°F
Efficiency	<b>2.622 kWh/mi</b>
MPGe	14
Estimated Range with 1 Full Charge	156 miles
<b>Cold Day</b>	
Passenger Count	40
Ambient Temperature	44°F
Efficiency	<b>2.260 kWh/mi</b>
MPGe	17
Estimated Range with 1 Full Charge	181 miles

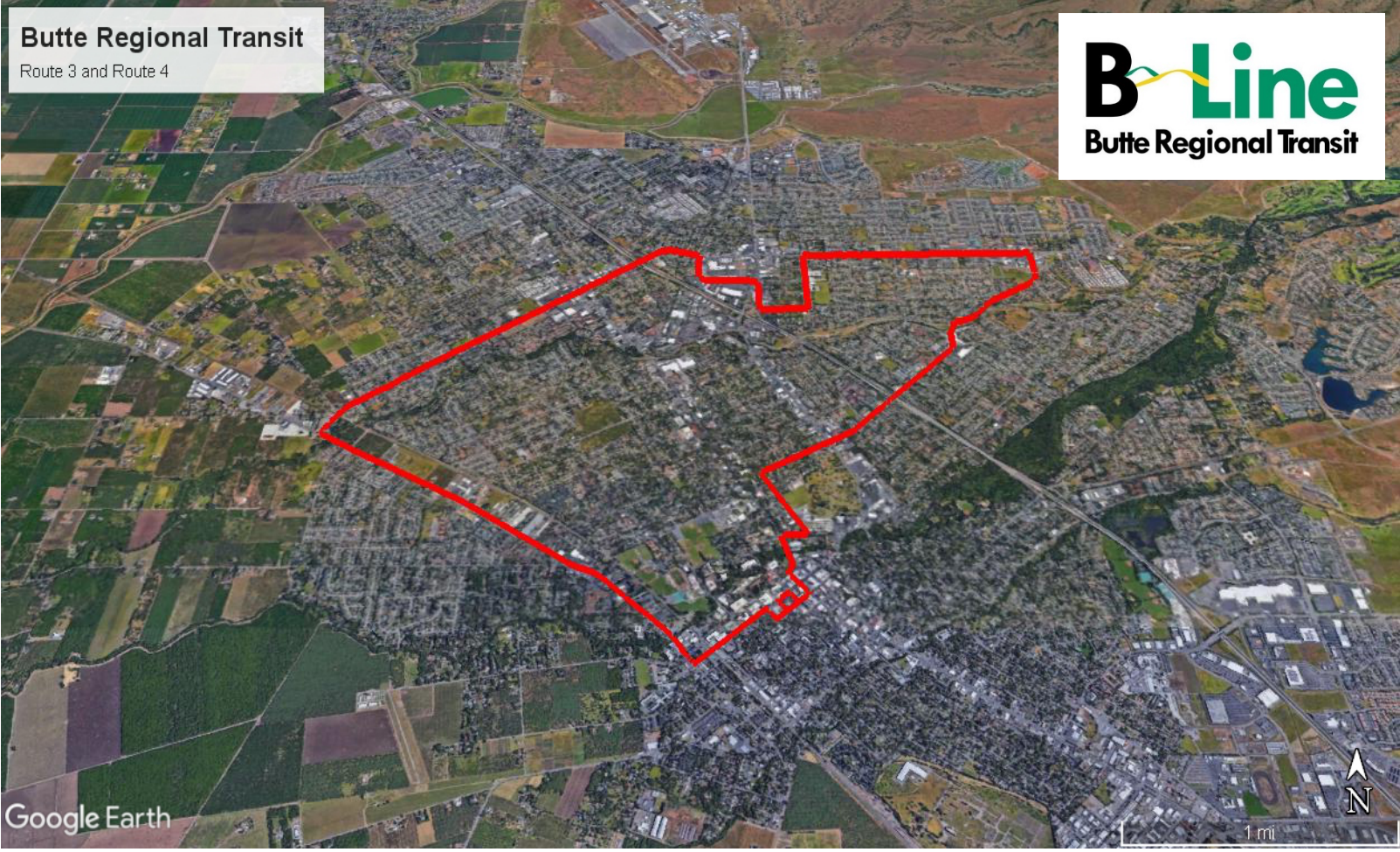

<b>Route Information</b>	
Route Name	<b>Route 3 and Route 4</b>
Distance	11.1 miles
Duration	48 minutes
Average Speed	14 MPH
Maximum Speed	41 MPH
Maximum Grade	2.2%
<b>Average Day Results</b>	
Passenger Count	40
Ambient Temperature	74°F
Efficiency	<b>1.733 kWh/mi</b>
MPGe	22
Total Energy Consumed	19.2 kWh
Estimated Range with 1 Full Charge	236 miles
System Energy Recaptured by Regen	28.6%
<b>Environmental and Operating Impact</b>	
<b>Hot Day</b>	
Passenger Count	40
Ambient Temperature	101°F
Efficiency	<b>2.129 kWh/mi</b>
MPGe	18
Estimated Range with 1 Full Charge	192 miles
<b>Cold Day</b>	
Passenger Count	40
Ambient Temperature	44°F
Efficiency	<b>1.821 kWh/mi</b>
MPGe	21
Estimated Range with 1 Full Charge	224 miles



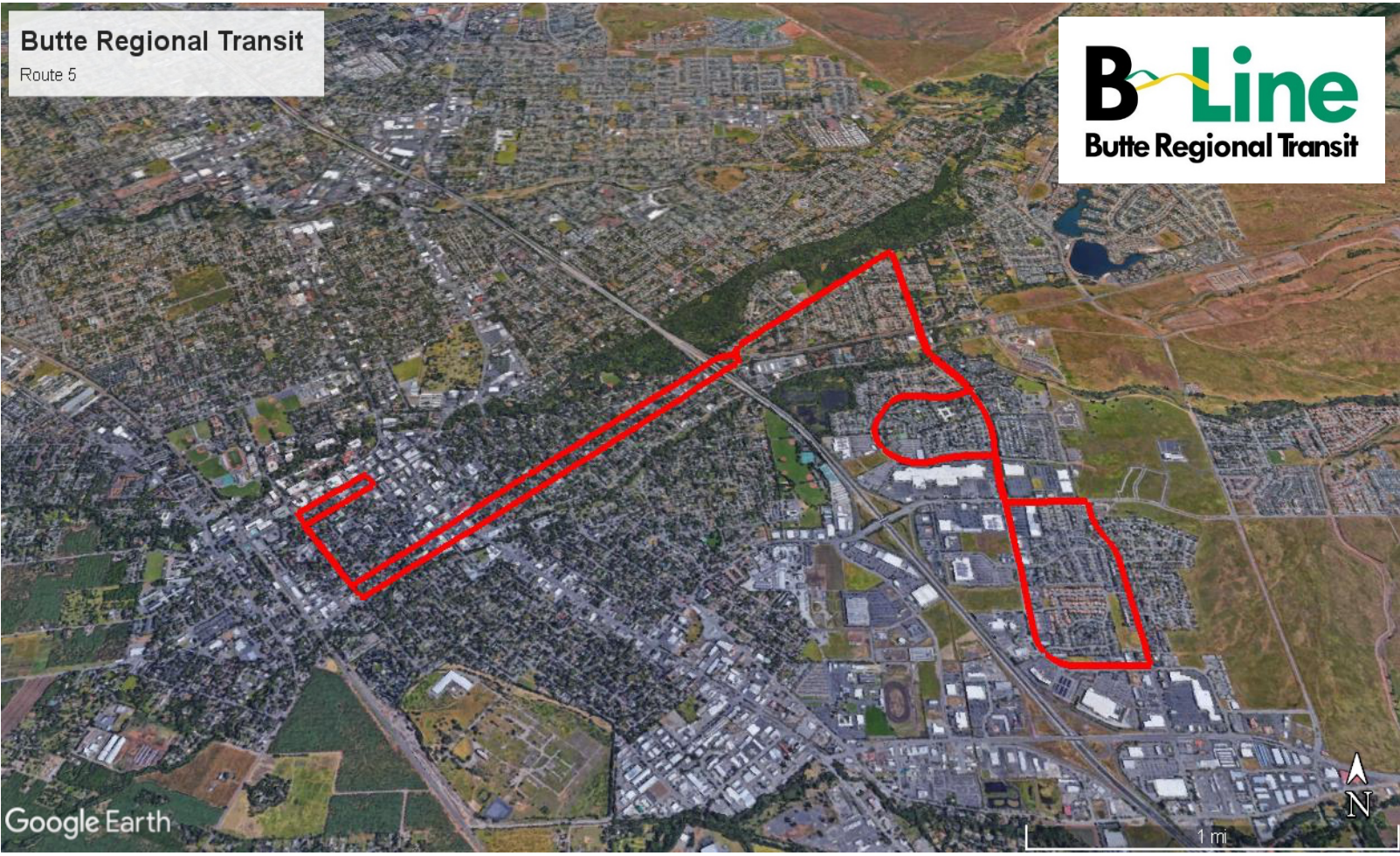

**Butte Regional Transit**  
Route 5



<b>Route Information</b>	
Route Name	<b>Route 5</b>
Distance	11.3 miles
Duration	48 minutes
Average Speed	14 MPH
Maximum Speed	34 MPH
Maximum Grade	2.2%
<b>Average Day Results</b>	
Passenger Count	40
Ambient Temperature	74°F
Efficiency	<b>1.773 kWh/mi</b>
MPGe	21
Total Energy Consumed	20.0 kWh
Estimated Range with 1 Full Charge	231 miles
System Energy Recaptured by Regen	31.3%
<b>Environmental and Operating Impact</b>	
<b>Hot Day</b>	
Passenger Count	40
Ambient Temperature	101°F
Efficiency	<b>2.164 kWh/mi</b>
MPGe	17
Estimated Range with 1 Full Charge	189 miles
<b>Cold Day</b>	
Passenger Count	40
Ambient Temperature	44°F
Efficiency	<b>1.882 kWh/mi</b>
MPGe	20
Estimated Range with 1 Full Charge	217 miles

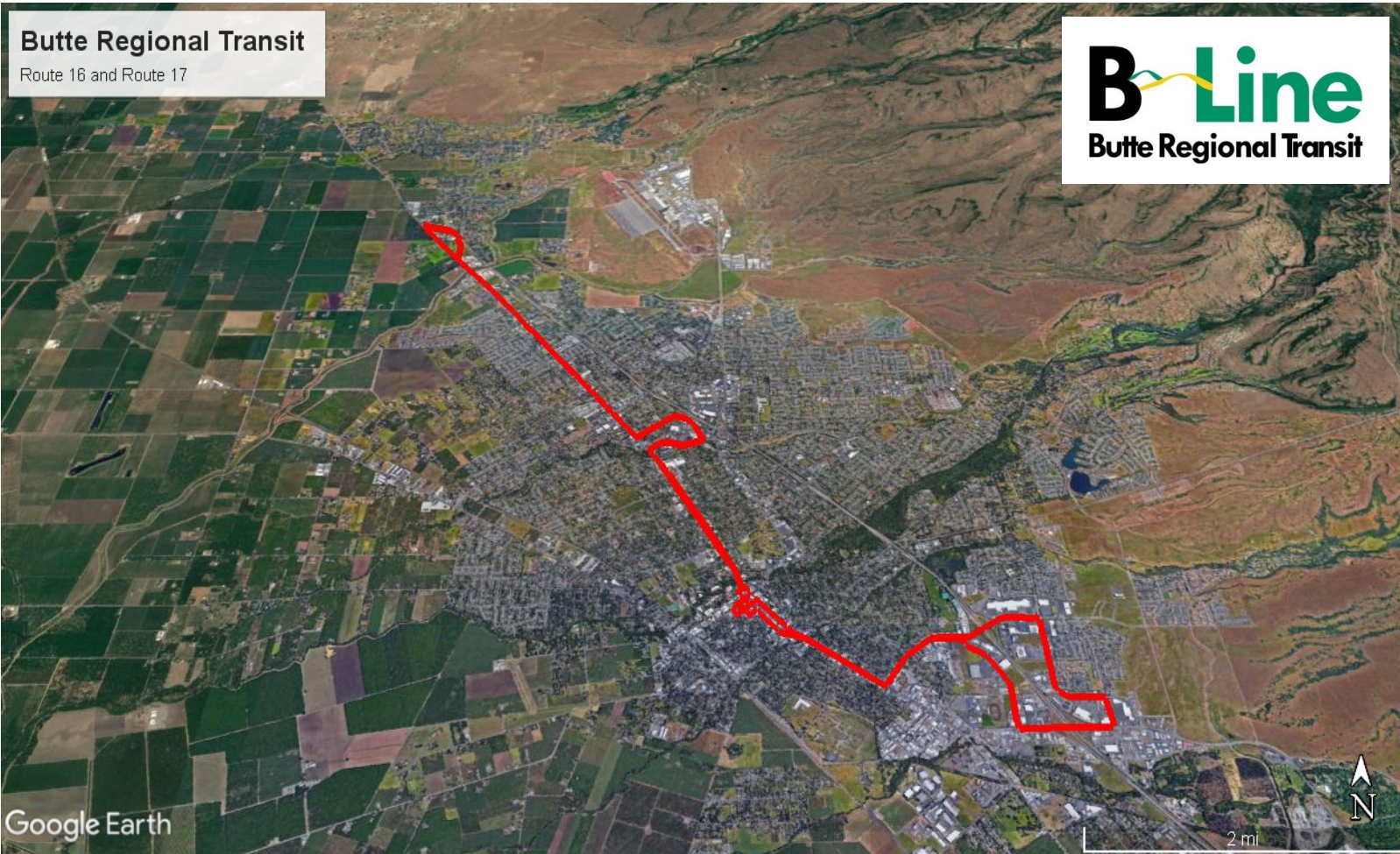

<b>Route Information</b>	
Route Name	<b>Route 16 and Route 17</b>
Distance	20.2 miles
Duration	108 minutes
Average Speed	11 MPH
Maximum Speed	46 MPH
Maximum Grade	2.1%
<b>Average Day Results</b>	
Passenger Count	40
Ambient Temperature	74°F
Efficiency	<b>1.943 kWh/mi</b>
MPGe	19
Total Energy Consumed	39.2 kWh
Estimated Range with 1 Full Charge	210 miles
System Energy Recaptured by Regen	29.3%
<b>Environmental and Operating Impact</b>	
<b>Hot Day</b>	
Passenger Count	40
Ambient Temperature	101°F
Efficiency	<b>2.434 kWh/mi</b>
MPGe	16
Estimated Range with 1 Full Charge	168 miles
<b>Cold Day</b>	
Passenger Count	40
Ambient Temperature	44°F
Efficiency	<b>2.043 kWh/mi</b>
MPGe	18
Estimated Range with 1 Full Charge	200 miles

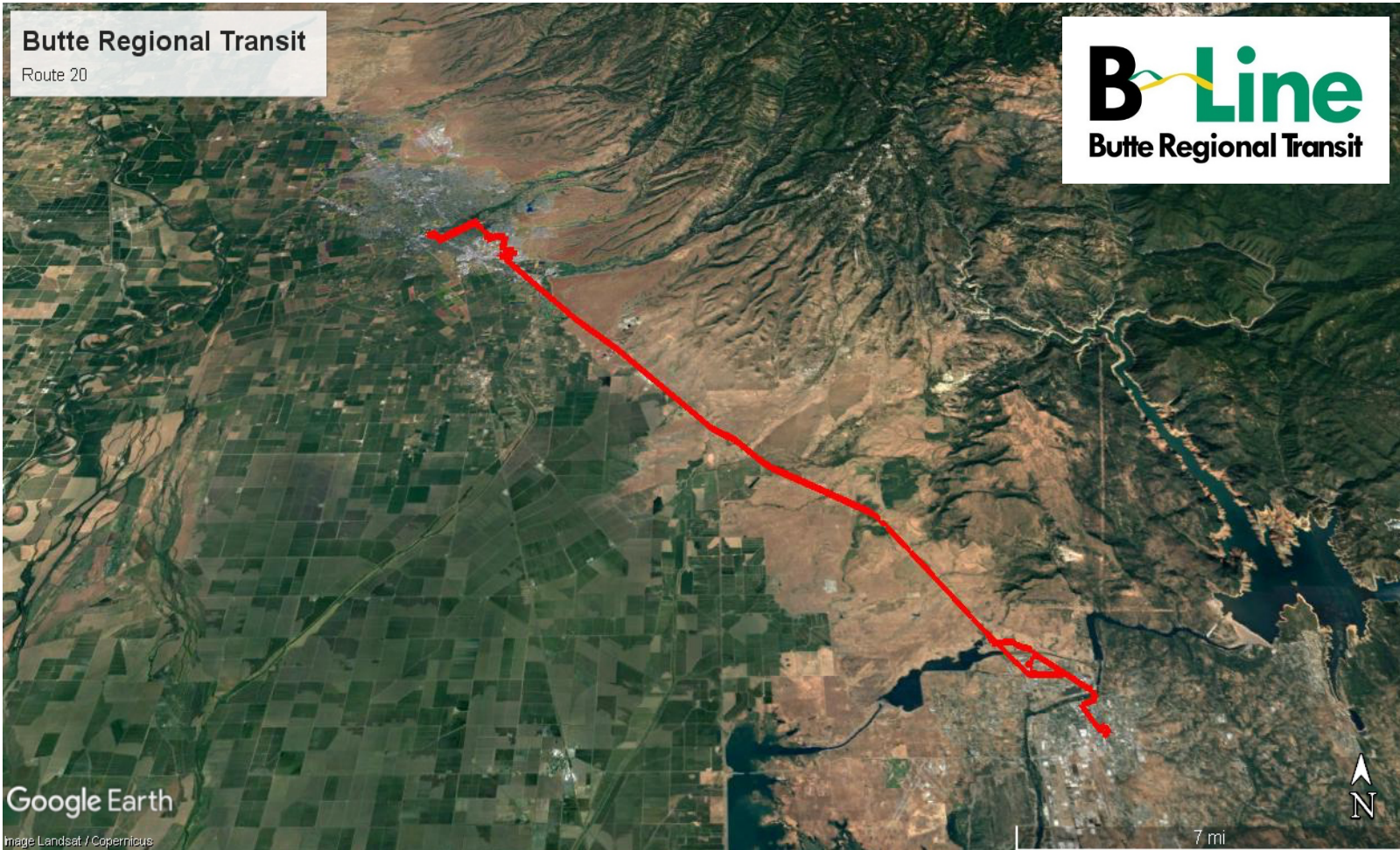

<b>Route Information</b>	
Route Name	<b>Route 20</b>
Distance	51.8 miles
Duration	111 minutes
Average Speed	28 MPH
Maximum Speed	65 MPH
Maximum Grade	3.3%
<b>Average Day Results</b>	
Passenger Count	40
Ambient Temperature	74°F
Efficiency	<b>1.946 kWh/mi</b>
MPGe	19
Total Energy Consumed	100.8 kWh
Estimated Range with 1 Full Charge	210 miles
System Energy Recaptured by Regen	14.9%
<b>Environmental and Operating Impact</b>	
<b>Hot Day</b>	
Passenger Count	40
Ambient Temperature	101°F
Efficiency	<b>2.124 kWh/mi</b>
MPGe	18
Estimated Range with 1 Full Charge	192 miles
<b>Cold Day</b>	
Passenger Count	40
Ambient Temperature	44°F
Efficiency	<b>2.032 kWh/mi</b>
MPGe	19
Estimated Range with 1 Full Charge	201 miles

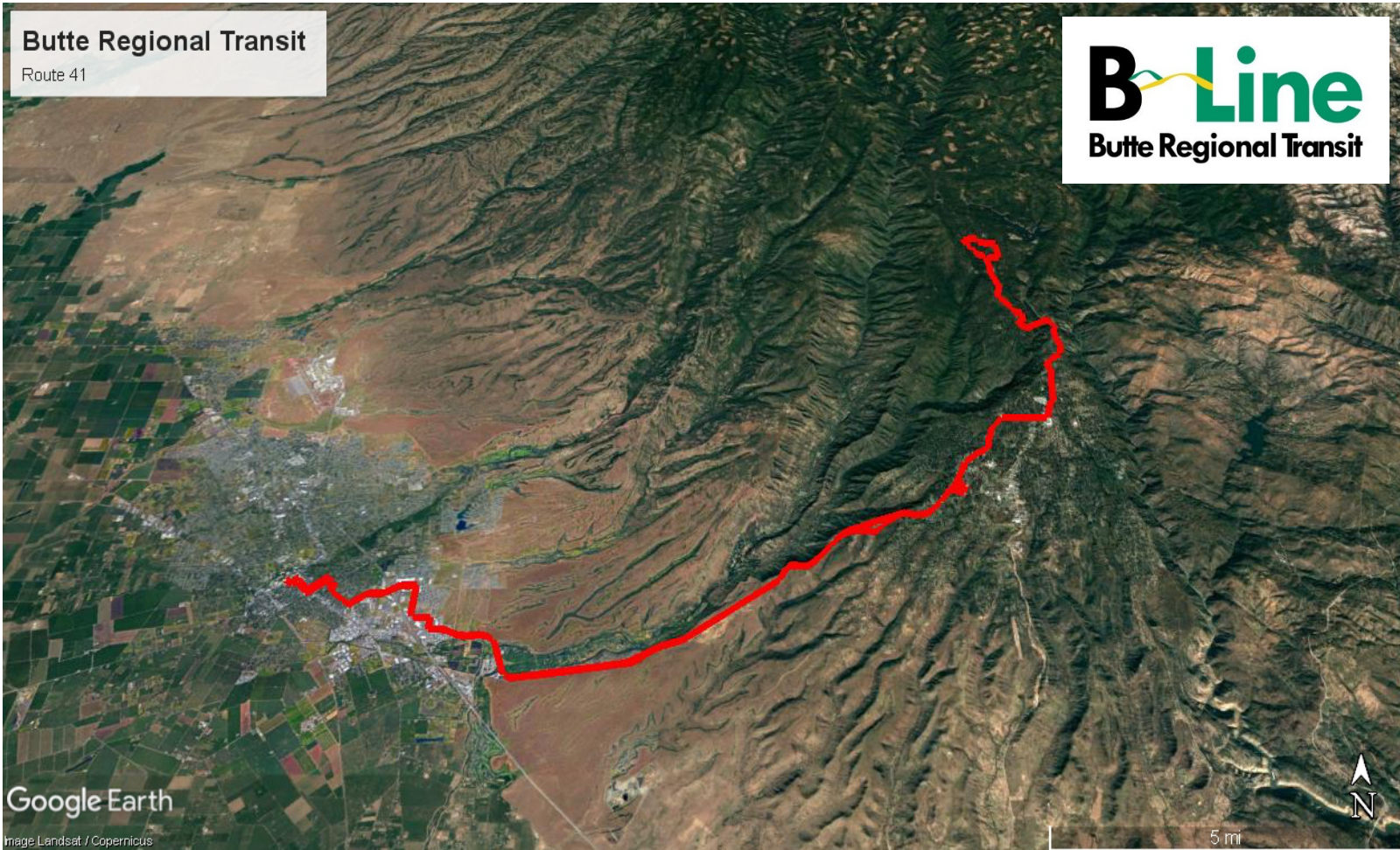

<b>Route Information</b>	
Route Name	<b>Route 41</b>
Distance	49.3 miles
Duration	128 minutes
Average Speed	23 MPH
Maximum Speed	62 MPH
Maximum Grade	7.7%
<b>Average Day Results</b>	
Passenger Count	40
Ambient Temperature	74°F
Efficiency	<b>1.846 kWh/mi</b>
MPGe	20
Total Energy Consumed	91.0 kWh
Estimated Range with 1 Full Charge	221 miles
System Energy Recaptured by Regen	26.7%
<b>Environmental and Operating Impact</b>	
<b>Hot Day</b>	
Passenger Count	40
Ambient Temperature	101°F
Efficiency	<b>2.083 kWh/mi</b>
MPGe	18
Estimated Range with 1 Full Charge	196 miles
<b>Cold Day</b>	
Passenger Count	40
Ambient Temperature	44°F
Efficiency	<b>1.901 kWh/mi</b>
MPGe	20
Estimated Range with 1 Full Charge	215 miles

Route						
	Average	Hot	Cold	Average	Hot	Cold
Route 2	185	156	181	257	218	241
Route 3 and 4	236	192	224	331	271	297
Route 5	231	189	217	322	266	289
Route 16 and 17	210	168	200	296	238	265
Route 20	210	192	201	299	274	276
Route 41	221	196	215	312	277	289

# Range Comparison

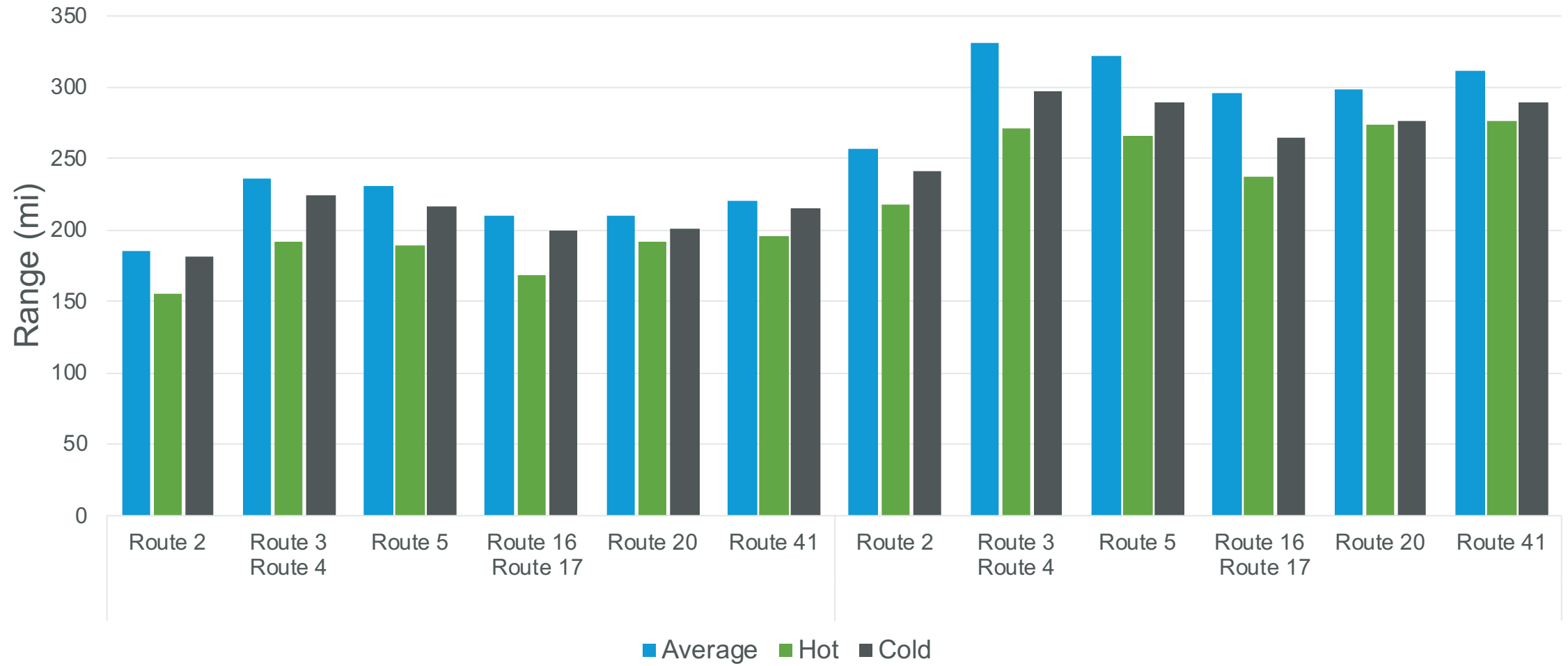

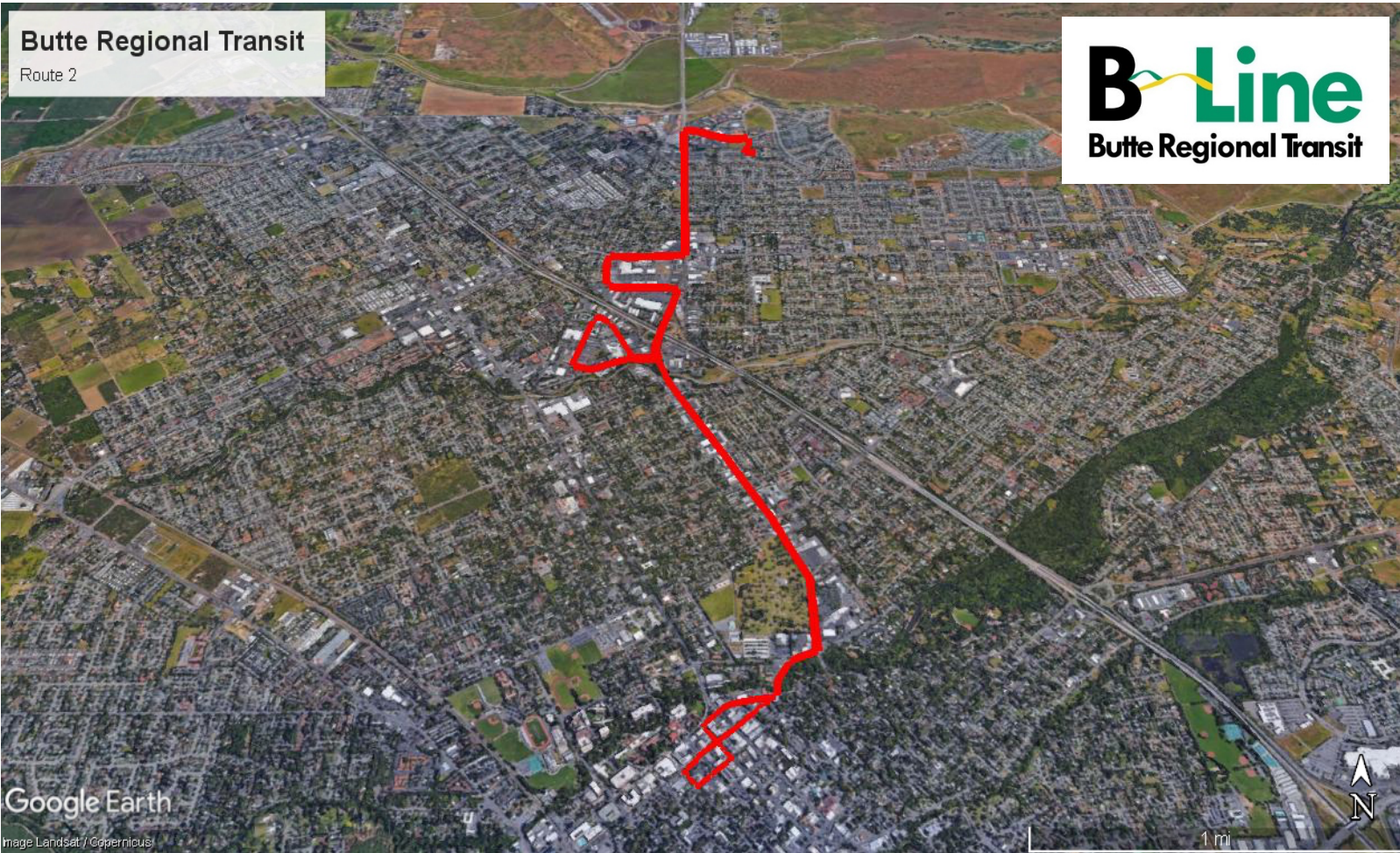

<b>Route Information</b>	
Route Name	<b>Route 2</b>
Distance	10.8 miles
Duration	48 minutes
Average Speed	14 MPH
Maximum Speed	39 MPH
Maximum Grade	2.5%
<b>Average Day Results</b>	
Passenger Count	40
Ambient Temperature	74°F
Efficiency	<b>2.388 kWh/mi</b>
MPGe	16
Total Energy Consumed	25.8 kWh
Estimated Range with 1 Full Charge	257 miles
System Energy Recaptured by Regen	28.3%
<b>Environmental and Operating Impact</b>	
<b>Hot Day</b>	
Passenger Count	40
Ambient Temperature	101°F
Efficiency	<b>2.807 kWh/mi</b>
MPGe	13
Estimated Range with 1 Full Charge	218 miles
<b>Cold Day</b>	
Passenger Count	40
Ambient Temperature	44°F
Efficiency	<b>2.546 kWh/mi</b>
MPGe	15
Estimated Range with 1 Full Charge	241 miles

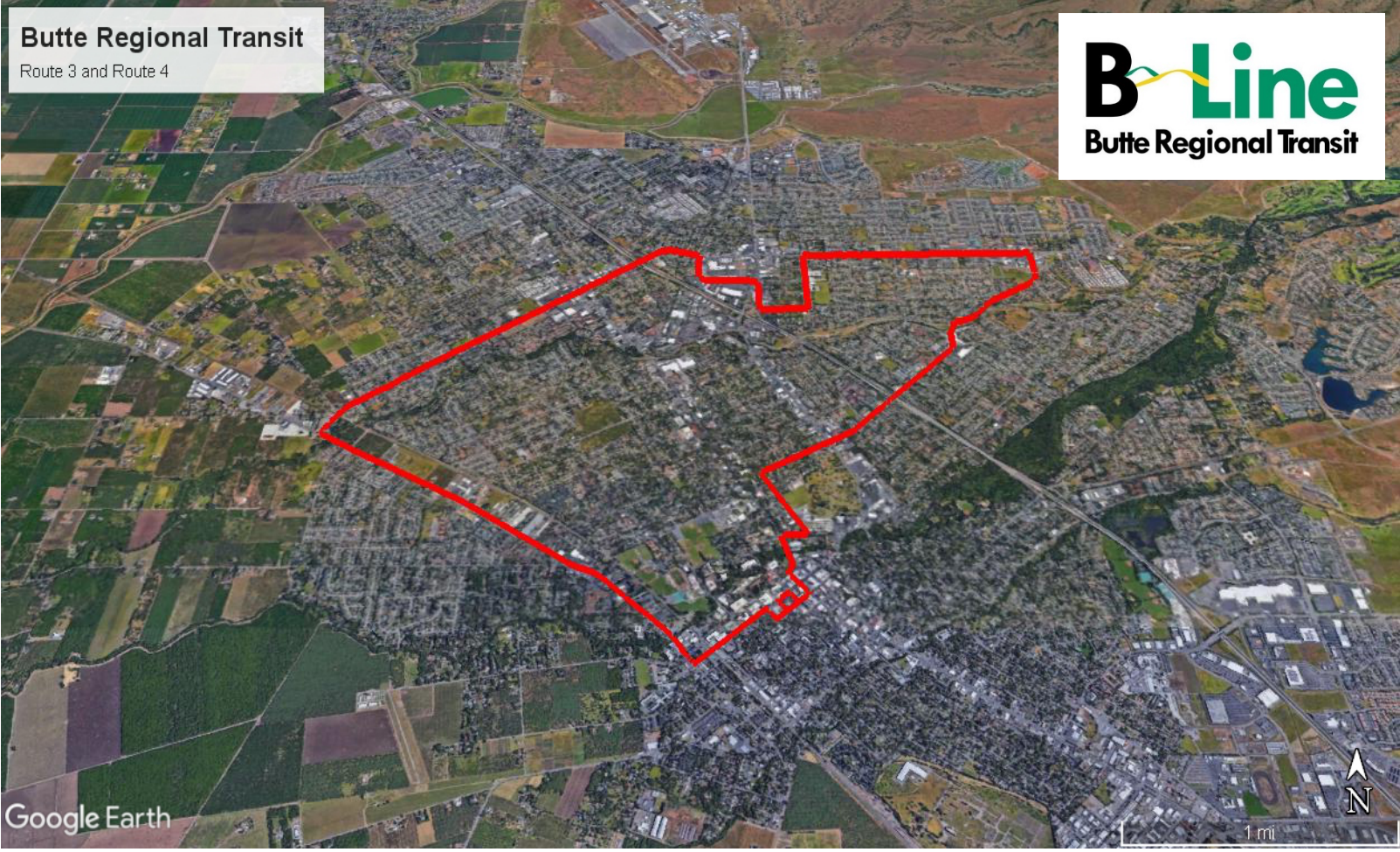

<b>Route Information</b>	
Route Name	<b>Route 3 and Route 4</b>
Distance	11.1 miles
Duration	48 minutes
Average Speed	14 MPH
Maximum Speed	41 MPH
Maximum Grade	2.2%
<b>Average Day Results</b>	
Passenger Count	40
Ambient Temperature	74°F
Efficiency	<b>1.850 kWh/mi</b>
MPGe	20
Total Energy Consumed	20.5 kWh
Estimated Range with 1 Full Charge	331 miles
System Energy Recaptured by Regen	28.9%
<b>Environmental and Operating Impact</b>	
<b>Hot Day</b>	
Passenger Count	40
Ambient Temperature	101°F
Efficiency	<b>2.259 kWh/mi</b>
MPGe	17
Estimated Range with 1 Full Charge	271 miles
<b>Cold Day</b>	
Passenger Count	40
Ambient Temperature	44°F
Efficiency	<b>2.064 kWh/mi</b>
MPGe	18
Estimated Range with 1 Full Charge	297 miles



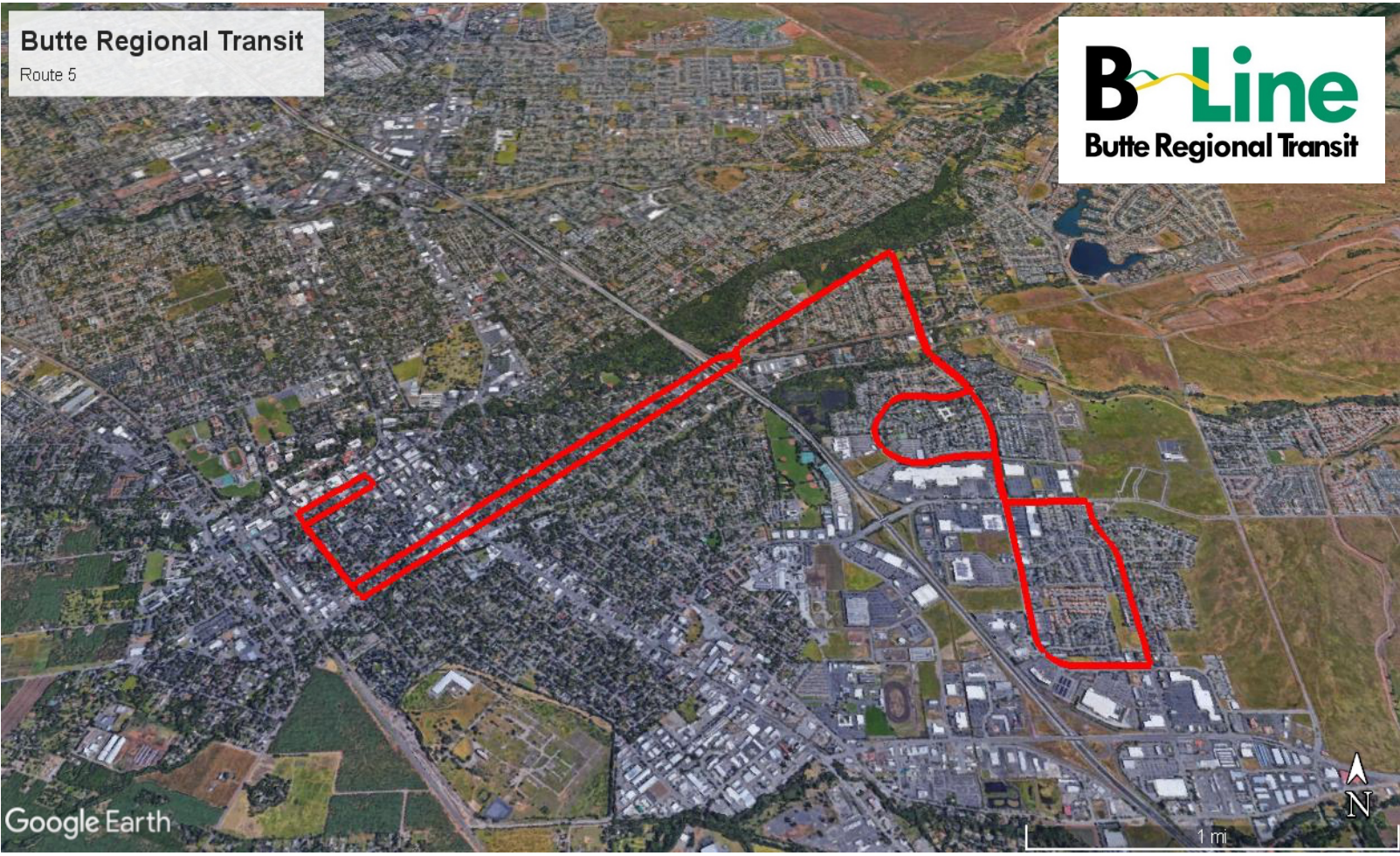

<b>Route Information</b>	
Route Name	<b>Route 5</b>
Distance	11.3 miles
Duration	48 minutes
Average Speed	14 MPH
Maximum Speed	34 MPH
Maximum Grade	2.2%
<b>Average Day Results</b>	
Passenger Count	40
Ambient Temperature	74°F
Efficiency	<b>1.906 kWh/mi</b>
MPGe	20
Total Energy Consumed	21.5 kWh
Estimated Range with 1 Full Charge	322 miles
System Energy Recaptured by Regen	31.4%
<b>Environmental and Operating Impact</b>	
<b>Hot Day</b>	
Passenger Count	40
Ambient Temperature	101°F
Efficiency	<b>2.309 kWh/mi</b>
MPGe	16
Estimated Range with 1 Full Charge	266 miles
<b>Cold Day</b>	
Passenger Count	40
Ambient Temperature	44°F
Efficiency	<b>2.119 kWh/mi</b>
MPGe	18
Estimated Range with 1 Full Charge	289 miles

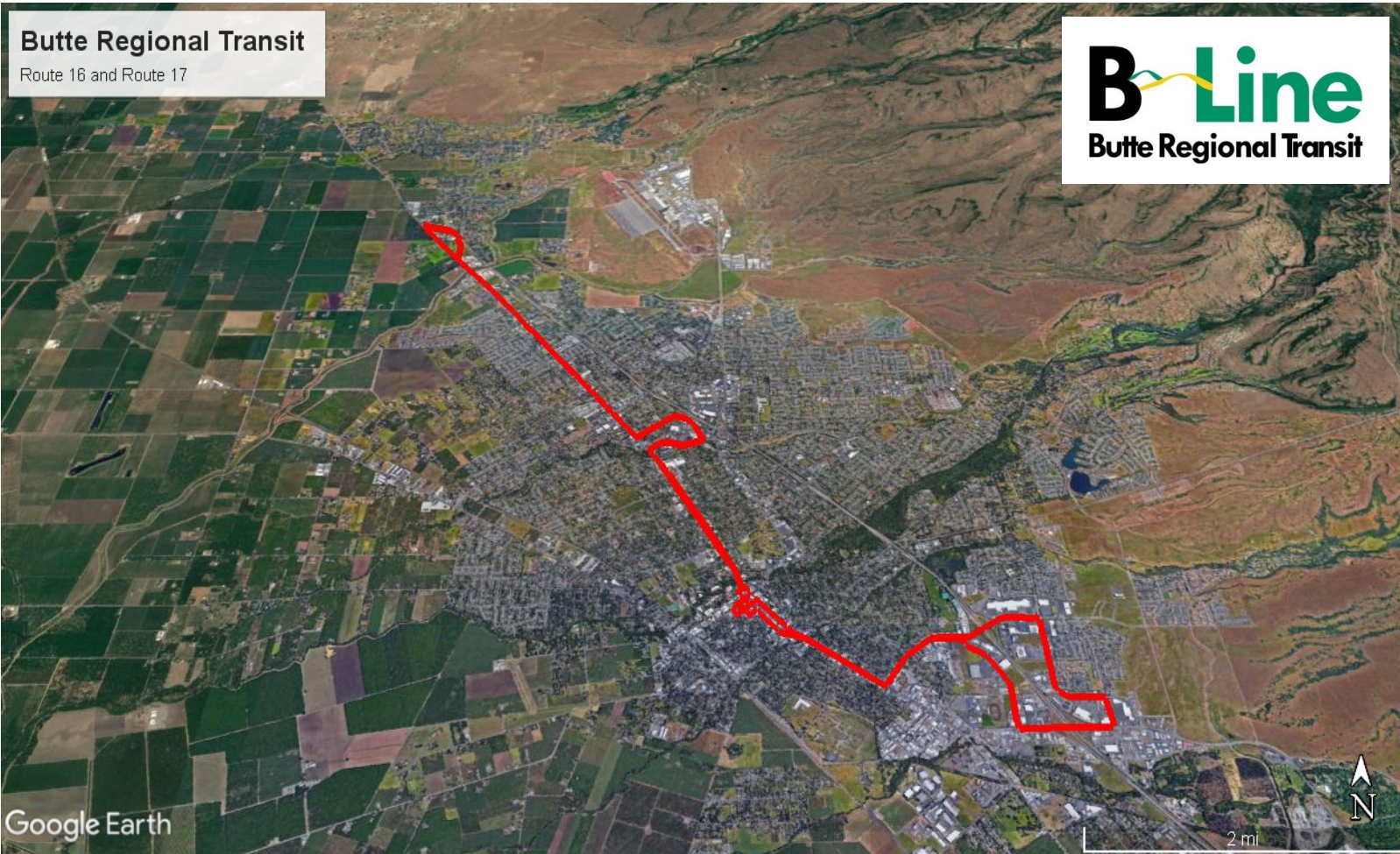

<b>Route Information</b>	
Route Name	<b>Route 16 and Route 17</b>
Distance	20.2 miles
Duration	108 minutes
Average Speed	11 MPH
Maximum Speed	46 MPH
Maximum Grade	2.1%
<b>Average Day Results</b>	
Passenger Count	40
Ambient Temperature	74°F
Efficiency	<b>2.073 kWh/mi</b>
MPGe	18
Total Energy Consumed	41.9 kWh
Estimated Range with 1 Full Charge	296 miles
System Energy Recaptured by Regen	29.6%
<b>Environmental and Operating Impact</b>	
<b>Hot Day</b>	
Passenger Count	40
Ambient Temperature	101°F
Efficiency	<b>2.581 kWh/mi</b>
MPGe	15
Estimated Range with 1 Full Charge	238 miles
<b>Cold Day</b>	
Passenger Count	40
Ambient Temperature	44°F
Efficiency	<b>2.317 kWh/mi</b>
MPGe	16
Estimated Range with 1 Full Charge	265 miles

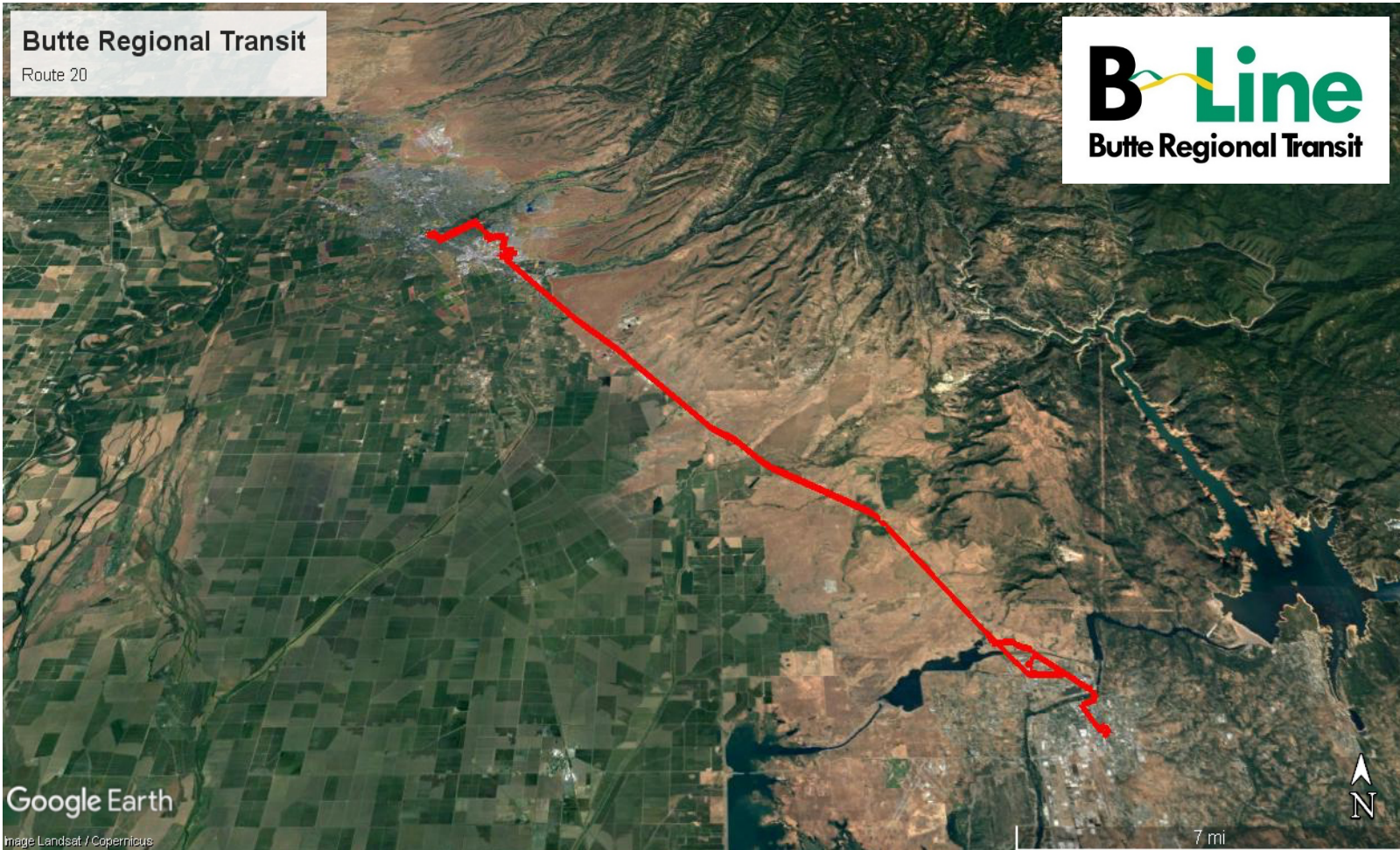

<b>Route Information</b>	
Route Name	<b>Route 20</b>
Distance	51.8 miles
Duration	111 minutes
Average Speed	28 MPH
Maximum Speed	65 MPH
Maximum Grade	3.3%
<b>Average Day Results</b>	
Passenger Count	40
Ambient Temperature	74°F
Efficiency	<b>2.053 kWh/mi</b>
MPGe	18
Total Energy Consumed	106.3 kWh
Estimated Range with 1 Full Charge	299 miles
System Energy Recaptured by Regen	15.2%
<b>Environmental and Operating Impact</b>	
<b>Hot Day</b>	
Passenger Count	40
Ambient Temperature	101°F
Efficiency	<b>2.236 kWh/mi</b>
MPGe	17
Estimated Range with 1 Full Charge	274 miles
<b>Cold Day</b>	
Passenger Count	40
Ambient Temperature	44°F
Efficiency	<b>2.225 kWh/mi</b>
MPGe	17
Estimated Range with 1 Full Charge	276 miles

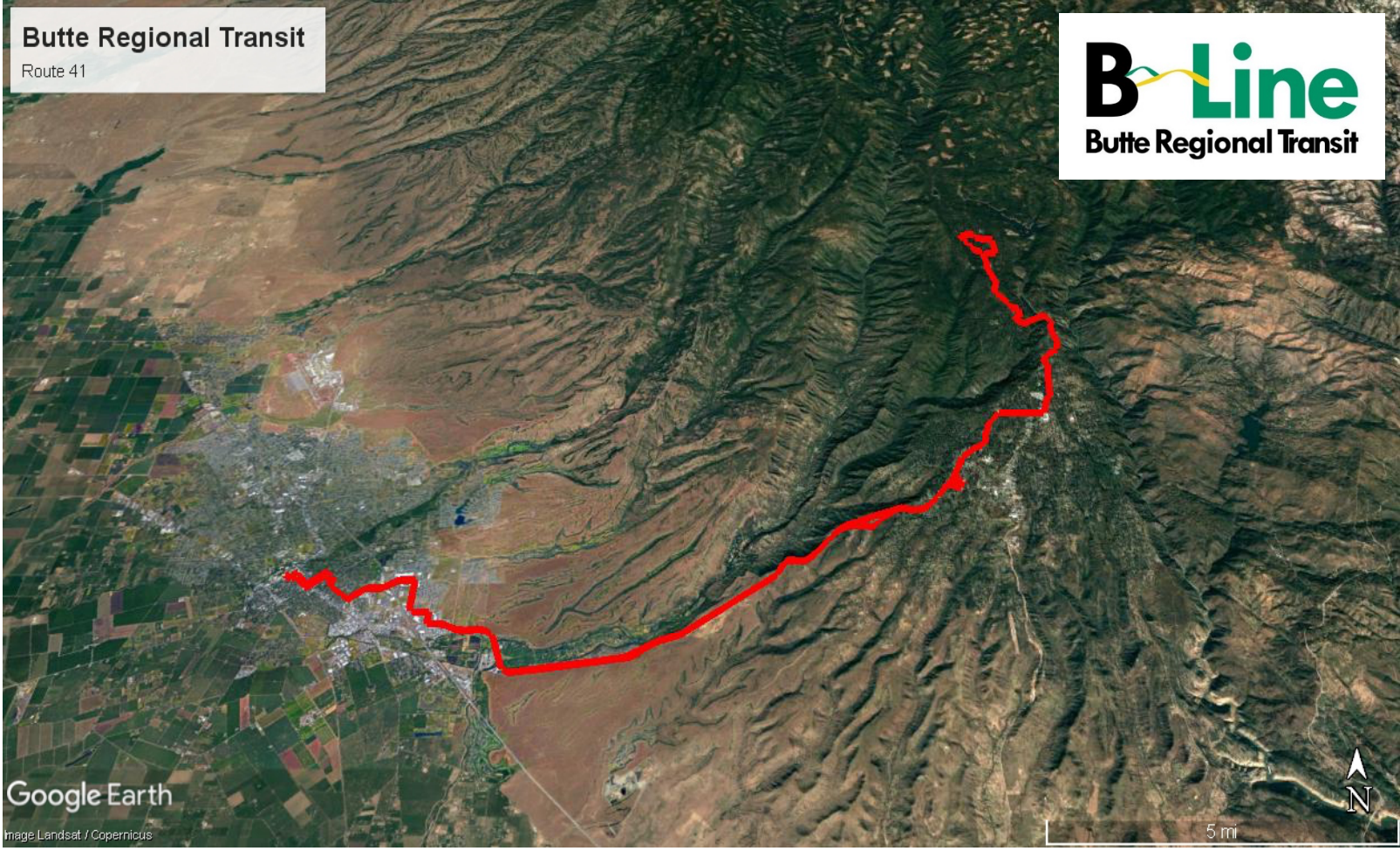

<b>Route Information</b>	
Route Name	<b>Route 41</b>
Distance	49.3 miles
Duration	128 minutes
Average Speed	23 MPH
Maximum Speed	62 MPH
Maximum Grade	7.7%
<b>Average Day Results</b>	
Passenger Count	40
Ambient Temperature	74°F
Efficiency	<b>1.964 kWh/mi</b>
MPGe	19
Total Energy Consumed	96.8 kWh
Estimated Range with 1 Full Charge	312 miles
System Energy Recaptured by Regen	26.9%
<b>Environmental and Operating Impact</b>	
<b>Hot Day</b>	
Passenger Count	40
Ambient Temperature	101°F
Efficiency	<b>2.210 kWh/mi</b>
MPGe	17
Estimated Range with 1 Full Charge	277 miles
<b>Cold Day</b>	
Passenger Count	40
Ambient Temperature	44°F
Efficiency	<b>2.123 kWh/mi</b>
MPGe	18
Estimated Range with 1 Full Charge	289 miles

## **CEQA Notice of Exemption**

# Notice of Exemption

Appendix E

To: Office of Planning and Research  
P.O. Box 3044  
1400 Tenth Street, Room 121  
Sacramento, CA 95812-3044

From: Butte County Association of Governments  
326 Huss Drive, Suite 150  
Chico, CA 95928

Butte County Clerk – Recorder  
155 Nelson Avenue  
Oroville, CA 95965

**Project Title:** Electric Vehicle (EV) Underground Charging Infrastructure Project

**Project Applicant:** Butte County Association of Governments (BCAG)/Butte Regional Transit (BRT)

**Project Location - Specific:** The proposed project is located on the 10-acre BCAG/BRT campus at 326 Huss Drive in Chico, CA, 95928

**Project Location - City:** Chico

**Project Location - County:** Butte

**Description of Nature, Purpose and Beneficiaries of Project:** The project will consist of establishing a new electrical service and affiliated underground infrastructure to accommodate the installation of charging equipment for the purpose of charging electric buses to be utilized by Butte Regional Transit (BRT) in existing fixed and dial ride public transit throughout Butte County and future adjacent county(ies) connecting regional public transit services.

**Name of Public Agency Approving Project:** Butte County Association of Governments – Butte Regional Transit

**Name of Person/Agency Carrying Out Project:** Butte County Association of Governments – Butte Regional Transit

**Exempt Status: (check one):**

- Ministerial (Sec. 21080(b)(1); 15268);
- Declared Emergency (Sec. 21080(b)(3); 15269(a));
- Emergency Project (Sec. 21080(b)(4); 15269(b)(c));
- Categorical Exemption. State type and section number:
  - 15061(b)(3) – Activities Covered by General Rule
  - 15301 (b) – Existing Facilities
  - 15303 (d) – New Construction or Conversion of Small Structures
  - 15304 (f) – Minor Alterations to Land
- Statutory Exemptions. State code number:

**Reasons why project is exempt:** See attached

**Lead Agency Contact Person:** Andy Newsum, Deputy Director - 530-809-4616

**If filed by applicant:**

1. Attach certified document of exemption finding.
2. Has a Notice of Exemption been filed by the public agency approving the project?  Yes  No

Signature: Andy Newsum

Date: 8-25-20

Title: Deputy Director

Signed by Lead Agency   Signed by Applicant

Authority cited: Sections 21083 and 21110, Public Resources Code. Date Received for filing at OPR: \_\_\_\_\_

Reference: Sections 21108, 21152, and 21152.1, Public Resources Code.  
Revised 2011

### **Categorical Exemption Identification:**

15061(b)(3) – Activities Covered by General Rule: The Butte County Association of Governments (BCAG) and Butte Regional Transit (BRT) have reviewed the proposed project pursuant to 1) CEQA guidelines Section 15002(k) – General Concepts, the three step process for deciding which document to prepare for a project subject to CEQA; and 2) CEQA Guidelines Section 15061 – Review for Exemption, procedures for determining if a project is exempt from CEQA. BCAG staff has determined that it can be seen with certainty there is no possibility the proposed EV underground charging infrastructure could have a significant adverse effect on the environment. Additionally, the project is exempt from CEQA pursuant to CEQA Guidelines and under the following Exemption categories:

15301 (b) – Existing Facilities: - The project will add new and utilize existing underground conduit on site within the corporate yard for the purpose of conveying an upgraded electrical service to electric vehicle (EV) charging pads in the vehicle storage area of the corporate yard. There will be minor physical alterations and modifications to existing facilities to accommodate the new electrical service which will include the cutting, trenching and patching asphalt within the corporate yard and within property boundaries.

15303 (d) – Extension of electrical to accommodate EV charging infrastructure. A new service will be established at the property right of way adjacent to Aztec Drive which borders the property.

15304 (f) – Minor trenching and backfilling to upgrade existing electrical conduit runs for EV charging infrastructure. 200 lineal feet of existing asphalt on the property will be cut, trenched and removed to accommodate the new electrical service. Following installation of the new electrical service, the asphalt will be replaced.

**DECLARATION OF FEES DUE**  
(California Fish and Game Code Section 711.4)

**NAME AND ADDRESS OF APPLICANT:**

Butte County Association of Governments  
326 Huss Drive, Suite 150  
Chico, CA 95928

FILING NO. \_\_\_\_\_

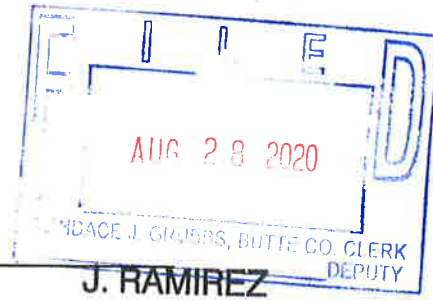

**Project Title/File Number:** Electric Vehicle (EV) Underground Charging infrastructure project:  
**APN#:** 039-060-126, 039-060-125

**CLASSIFICATION OF ENVIRONMENTAL DOCUMENT:**

1. NOTICE OF EXEMPTION/STATEMENT OF EXEMPTION
  - A. Statutorily or Categorically Exempt  
\$50.00 Clerk's Documentary Handling Fee
  - B. De Minimis Impact – Certificate of Fee Exemption  
\$50.00 Clerk's Documentary Handling Fee
  
2. NOTICE OF DETERMINATION – FEE REQUIRED
  - A. Negative Declaration  
\$2,280.75 State Filing Fee  
\$50.00 Clerk's Documentary Handling Fee
  - B. Environmental Impact Report  
\$2,995.25 State Filing Fee  
\$50.00 Clerk's Documentary Handling Fee
  
3.  OTHER (Specify)  
\$50.00 Clerk's Documentary Handling Fee

**PAYMENT/NON-PAYMENT OF FEES**

1.  **PAYMENT:** The above fees have been paid  
See attached receipt(s)
  
2.  **NON-PAYMENT:** The above fees are not required. Not paid.

Butte County Association of Governments  
By: Jon A. Clark  
Title: Executive Director  
Lead Agency: Butte County Association of Governments  
Date: August 27<sup>th</sup>, 2020

TWO COPIES OF THIS FORM MUST BE COMPLETED AND SUBMITTED WITH ALL ENVIRONMENTAL DOCUMENTS FILED WITH THE BUTTE COUNTY CLERK'S OFFICE.

THREE COPIES OF ALL NECESSARY DOCUMENTATION ARE REQUIRED FOR FILING.

ALL APPLICABLE FEES ARE DUE AND PAYABLE PRIOR TO THE FILING OF ANY ENVIRONMENTAL DOCUMENT WITH THE BUTTE COUNTY CLERK'S OFFICE. MAKE CHECKS PAYABLE TO THE COUNTY OF BUTTE.





State of California - Department of Fish and Wildlife  
**2020 ENVIRONMENTAL FILING FEE CASH RECEIPT**  
 DFW 753.5a (REV. 06/01/20) Previously DFG 753.5a

**Print** **StartOver** **Save**

RECEIPT NUMBER:  
 04 — 08/28/2020 — 068  
 STATE CLEARINGHOUSE NUMBER (If applicable)

**SEE INSTRUCTIONS ON REVERSE. TYPE OR PRINT CLEARLY.**

LEAD AGENCY <b>Butte County Association of Governments</b>	LEAD AGENCY EMAIL <i>anewsun@bcag.org</i>	DATE <b>08/28/2020</b>
COUNTY/STATE AGENCY OF FILING <b>Butte</b>	DOCUMENT NUMBER	

PROJECT TITLE

**Electric Vehicle (EV) Underground Charging Infrastructure Project**

PROJECT APPLICANT NAME Butt County Association of Governments (BCAG)/Butte Regional Transit (BRT)	PROJECT APPLICANT EMAIL	PHONE NUMBER <b>(530) 809-4616</b>
PROJECT APPLICANT ADDRESS <b>326 Huss Drive, Suite 150</b>	CITY <b>Chico</b>	STATE <b>CA</b>
		ZIP CODE <b>95928</b>

**PROJECT APPLICANT** (Check appropriate box)

- Local Public Agency    
  School District    
  Other Special District    
  State Agency    
  Private Entity

**CHECK APPLICABLE FEES:**

- |   |            |    |             |
|---|------------|----|-------------|
| <input type="checkbox"/> Environmental Impact Report (EIR)  | \$3,343.25 | \$ | <u>0.00</u> |
| <input type="checkbox"/> Mitigated/Negative Declaration (MND)(ND)                                   | \$2,406.75 | \$ | <u>0.00</u> |
| <input type="checkbox"/> Certified Regulatory Program (CRP) document - payment due directly to CDFW | \$1,136.50 | \$ | <u>0.00</u> |

- Exempt from fee  
 Notice of Exemption (attach)  
 CDFW No Effect Determination (attach)  
 Fee previously paid (attach previously issued cash receipt copy)

- |   |          |    |              |
|---|----------|----|--------------|
| <input type="checkbox"/> Water Right Application or Petition Fee (State Water Resources Control Board only) | \$850.00 | \$ | <u>0.00</u>  |
| <input checked="" type="checkbox"/> County documentary handling fee   |          | \$ | <u>50.00</u> |
| <input type="checkbox"/> Other  |          | \$ | <u></u>      |

**PAYMENT METHOD:**

- Cash    
  Credit    
  Check    
  Other    
 TOTAL RECEIVED \$ 50.00

SIGNATURE <b>X J. RAMIREZ</b>	AGENCY OF FILING PRINTED NAME AND TITLE <b>J. Ramirez, Butte County Deputy Clerk Recorder</b>
----------------------------------	--



Clerk-Recorder's Department  
County of Butte  
CANDACE J. GRUBBS  
County Clerk-Recorder

---

1 FISH AND GAME CLERKS FEE	50.00
Total Charges	50.00
CASH	50.00
Total Tendered	50.00
Change	.00

---

8/28/2020 12:10:10 PM 2020082800122  
Printed: Aug 28 2020 12:10PM by JR ECR-REC-10  
Thank You



Requested By Public

## Project Site Photos – August 2020



**Westerly at bus solar canopy parking in direction of expected (future) charging head locations/area**



**Northerly at bus solar canopy and expected charging head locations/area**



**Expected underground to surface infrastructure installation**



**Existing switchgear at northeast area of campus property**



**Southerly at possible new electrical service (location #1)**



**Southeasterly at possible new electrical service location #2 (east of location #1)**

## Aerial view of BCAG/BRT campus

Latitude 39 deg. 42 min. 17.79 sec. N

Longitude 121 deg. 49 min. 17.17 sec. W

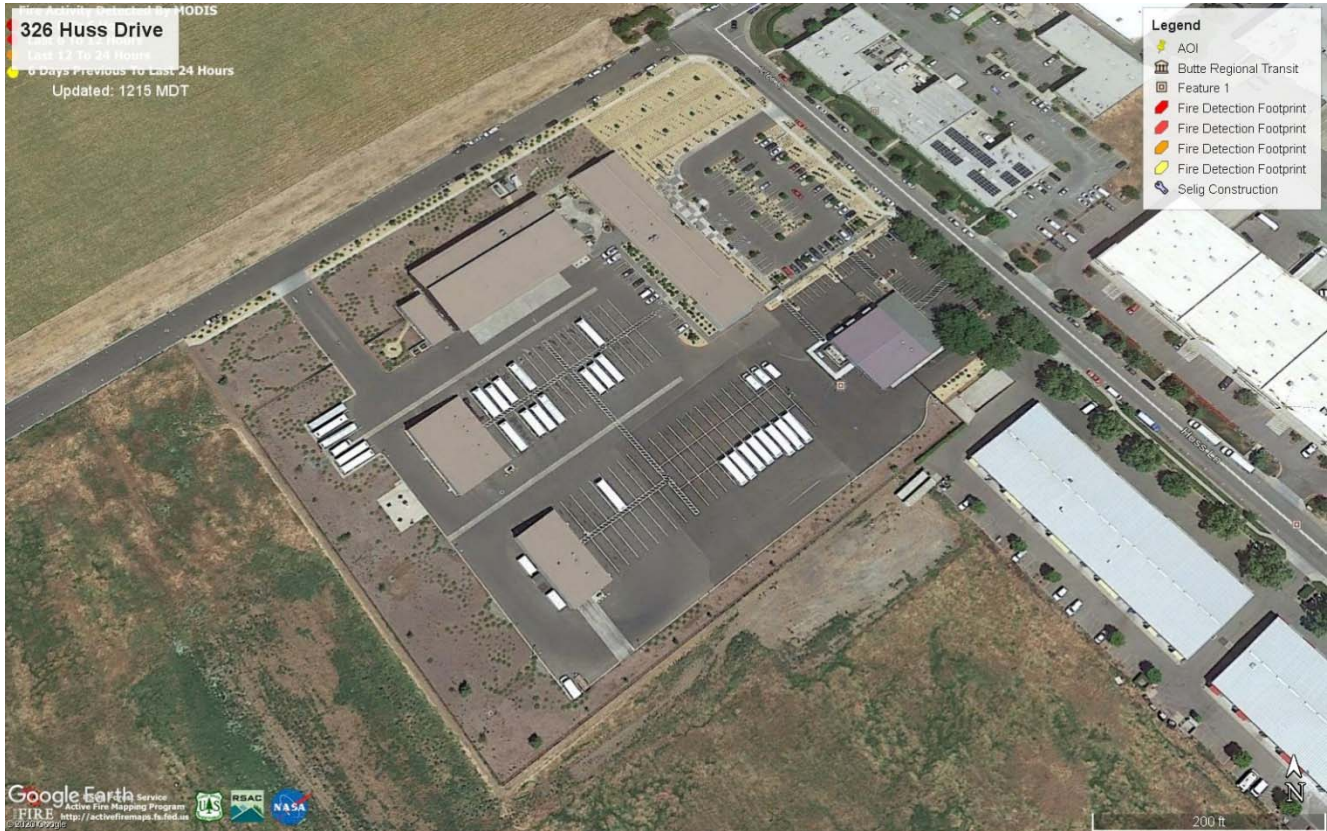

**Note: Imagery does not show currently installed solar canopies as shown in photographs. Canopies are installed and oriented over existing bus parking areas/stalls shown in above image.**